



Husqvarna®



553RBX

Contents

Introduction.....	2	Troubleshooting.....	24
Safety.....	4	Transportation, storage and disposal.....	25
Safety instructions for maintenance.....	10	Transportation and storage.....	25
Fuel safety.....	11	Technical data.....	25
Assembly.....	11	Technical data.....	25
Operation.....	15	Accessories.....	26
Maintenance.....	20	EC Declaration of Conformity.....	28

Introduction

Product description

This product is a brushcutter with a combustion engine.

Work is constantly in progress to increase your safety and efficiency during operation. Speak to your servicing dealer for more information.

Intended use

Use the product with a grass blade or a trimmer head to cut different types of vegetation. Do not use the product for other tasks than grass trimming and grass clearing.

Product overview

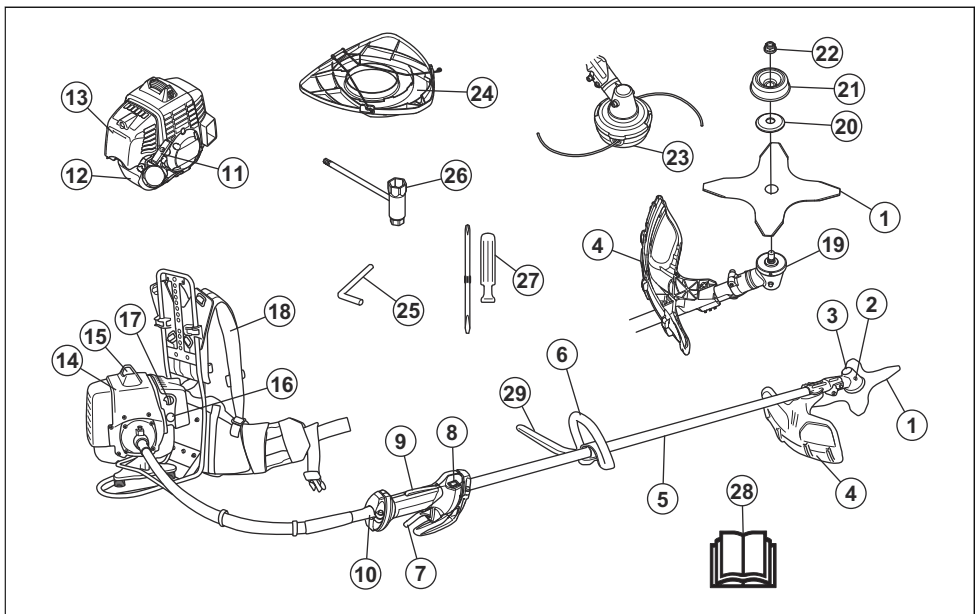

1. Blade

2. Grease filler cap, bevel gear

3. Bevel gear
4. Cutting attachment guard
5. Shaft
6. Loop handle
7. Throttle trigger
8. Stop switch
9. Throttle trigger lockout
10. Flexible drive shaft coupling
11. Starter rope handle
12. Fuel tank
13. Air filter cover
14. Cylinder cover
15. Spark plug cap and spark plug
16. Air purge bulb
17. Choke control
18. Harness
19. Drive disc
20. Support flange
21. Support cup
22. Locknut
23. Trimmer head
24. Transport guard
25. Locking pin
26. Socket wrench
27. Screwdriver
28. Operator's manual
29. J-handle

Symbols on the product



WARNING! Be careful and use the product correctly. This product can cause serious injury or death to the operator or others.



Read the operator's manual carefully and make sure that you understand the instructions before you use this product.



Use a protective helmet in locations where objects can fall on you. Use approved hearing protection and approved eye protection.



max rpm Maximum speed of the output shaft.



The product agrees with the applicable EC directives.



The product can cause objects to eject, which can cause injury.



Keep a minimum distance of 15 m/50 ft. to persons and animals during operation of the product.



Risk of blade thrust if the cutting equipment touches an object that it does not immediately cut. The product can cut off body parts. Keep a minimum of 15 /50 ft. distance to persons and animals during operation of the product.



The arrows show the limit for the handle position.



Choke.



Air purge bulb.



Use approved protective gloves.



Use heavy-duty slip-resistant boots.



Noise emission to the environment refers to the European Community's Directive. The emission of the product is specified in the Technical data chapter and on the label.



Keep all parts of your body away from hot surfaces.

yyyywwxxxx

The rating plate shows the serial number. **yyyy** is the production year and **ww** is the production week.

Note: Other symbols/decals on the product refer to certification requirements for other commercial areas.

EU V



WARNING: Tampering with the engine voids the EU type-approval of this product.

Safety

Safety definitions

Warnings, cautions and notes are used to point out specially important parts of the manual.



WARNING: Used if there is a risk of injury or death for the operator or bystanders if the instructions in the manual are not obeyed.



CAUTION: Used if there is a risk of damage to the product, other materials or the adjacent area if the instructions in the manual are not obeyed.

Note: Used to give more information that is necessary in a given situation.

General safety instructions



WARNING: Read the warning instructions that follow before you use the product.

- A clearing saw, brushcutter or trimmer can be dangerous if used carelessly or incorrectly and can cause serious injury or death to the operator or others. It is extremely important that you read and understand the contents of this operator's manual.
- Under no circumstances may the design of the product be modified without the permission of the manufacturer. Never use a product that has been modified in any way from its original specification and always use original accessories. Non-authorized modifications and/or accessories can result in serious personal injury or the death of the operator or others.
- The inside of the muffler contain chemicals that may be carcinogenic. Avoid contact with these elements in the event of a damaged muffler.
- This product produces an electromagnetic field during operation. This field may under some circumstances interfere with active or passive medical implants. To reduce the risk of serious or fatal injury, we recommend persons with medical implants to consult their physician and the medical implant manufacturer before operating this product.

Safety instructions for assembly



WARNING: Read, understand and obey these instructions carefully before you use the product.

- Remove the spark plug cap from the spark plug before you assemble the product.

- Use approved protective gloves.
- When you use a saw blade or a grass blade, make sure that the correct handlebar, the blade guard and the harness are attached to the product.
- A defective or incorrect guard can cause injury. Do not use a cutting attachment that does not have an approved guard attached.
- Attach the clutch cover and shaft correct before you start the product to prevent the clutch to fall of.
- Make sure that you assemble the cover and shaft correct before you start the engine.
- The drive disc and support flange must engage correctly in the centre hole of the cutting attachment. A cutting attachment that is attached incorrectly can cause injury or death.
- To operate the product safely and prevent injury to the operator or other persons, the product must always be attached correctly to the harness.

Personal protective equipment



WARNING: Read the warning instructions that follow before you use the product.

- Always use approved personal protective equipment when you use the product. Personal protective equipment cannot fully prevent injury but it decreases the degree of injury if an accident does occur. Let your dealer help you select the right equipment.
- Use a protective helmet where there is a risk of falling objects.

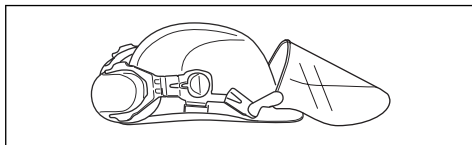

- Use approved hearing protection that provides adequate noise reduction. Long-term exposure to noise can result in permanent hearing impairment.

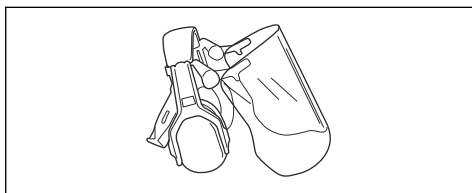

- Use approved eye protection. If you use a visor, you must also use approved protective goggles. Approved protective goggles must comply with the

ANSI Z87.1 standard in the USAs or EN 166 in EU countries.

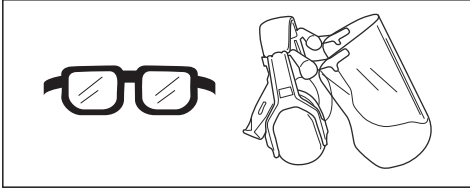

- Use gloves when necessary, for example when you attach, examine or clean the cutting equipment.

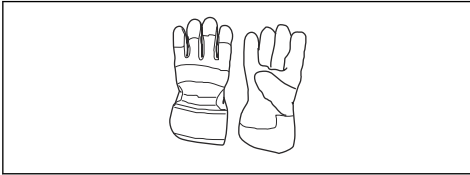

- Use sturdy non-slip boots.



- Use clothing made of a strong fabric. Always use heavy, long pants and long sleeves. Do not use loose clothing that can catch on twigs and branches. Do not wear jewelry, short pants, sandals or go with bare feet. Put your hair up safely above shoulder level.
- Keep first aid equipment close at hand.



Safety devices on the product

For information about where to find the safety devices, see *Product overview on page 2*.



WARNING: Read the warning instructions that follow before you use the product.

- Do not use a product with defective safety devices. Do a check of and do maintenance on the safety devices regularly. If the safety devices are defective, speak to your Husqvarna service agent.

- Do not make changes to safety devices. Do not use the product if protective covers, safety switches or other protective devices are not attached or are defective.
- For all service and repair work on the product, especially for the safety devices, special training is necessary. If the safety devices fail the checks given in this operator's manual, you must let a service agent help you. We guarantee that professional repairs and service is available. If your dealer is not a service agent, speak to them for information about the nearest service agent.
- Do not use a cutting attachment without an approved and correctly attached cutting attachment guard. See *Accessories on page 26*.

Safety instructions for operation



WARNING: Read the warning instructions that follow before you use the product.

- Never use a harness with a defective quick release. When using a brush cutter it must always be hooked securely to the harness. Otherwise you will be unable to control the brush cutter safely and this can result in injury to yourself or others.
- Always hold the product with both hands. Hold the product on the right side of your body. Keep the cutting attachment below waist level. Connect the product to the suspension ring on the harness. Keep all parts of your body away from the hot surfaces. Keep all parts of your body away from the rotating cutting attachment.
- Learn and understand the difference between forestry clearing, grass clearing and grass trimming before you use the product.
- Never use a product that has been modified in any way from its original specification.
- Never use a product that is faulty. Carry out the safety checks, maintenance and service instructions described in this manual. Some maintenance and service measures must be carried out by trained and qualified specialists. Refer to *Maintenance on page 20*.
- Use personal protective equipment. Refer to *Personal protective equipment on page 4*.
- Do not use the product in bad weather, such as dense fog, heavy rain, strong wind, intense cold, etc. Working in bad weather is tiring and often brings added risks, such as icy ground, unpredictable felling direction, etc.
- Take great care when cutting a tree that is in tension. A tree that is in tension may spring back to its normal position before or after being cut. If you position yourself incorrectly or make the cut in the wrong place the tree may hit you or the product and cause you to lose control. Both situations can cause serious personal injury.

- The only accessories you can operate with this engine unit are the cutting attachments we recommend. Refer to *Accessories on page 26*.
- Watch out for thrown objects. Always wear approved eye protection. Never lean over the cutting attachment guard. Stones, rubbish, etc. can be thrown up into the eyes causing blindness or serious injury.
- Never use the product if you are tired, if you are ill, if you have consumed alcohol, or if you are taking other drugs or medication that can affect your vision, judgement or coordination.
- Long-term exposure to noise can result in permanent hearing loss. Always use approved hearing protection.
- Listen for warning signals and loud voices when you use hearing protection. Always remove your hearing protection when the engine stops.
- Carry out an overall inspection of the product before use. Refer to *Product overview on page 2*.
- Never use the product if it is changed or defective.
- Make sure that the spark plug cap and ignition lead are not damaged to prevent the risk of electrical shock.
- Look around the work area to make sure that no persons, animals or objects have a negative effect on the safety of the operation of the product.
- Look around the work area to make sure that no persons or animals touch the cutting attachment or are hit by objects that are ejected from the cutting attachment.
- Examine the work area. Remove all loose objects, such as stones, broken glass, nails, steel wire and string, that can eject or wind around the cutting attachment.
- Do not use the product in a situation or location where you can not get aid if an accident occurs.
- Do not use the product without a guard.
- Make sure that persons or animals keep a distance of a minimum of 15 m/50 ft during work. Always look behind you before you turn around with the product. Stop the product immediately if a person or animal enters the 15 m/50 ft safety zone. If more than one operator does work in the same area, keep a safety distance of a minimum of 2 times the tree height and a minimum of 15 m/50 ft.
- Make sure that you can move safely and have a safe stance. Examine the area around you for obstacles such as roots, rocks, branch and ditches. Be careful during work on slopes.
- Do not overreach. Keep a stable position of the feet and a good balance at all times.
- Before you start the product, put it on a flat surface, at a minimum of 3 m from the fuel source and from where you fill fuel. Make sure that there are no objects near or touching the cutting attachment.
- If the cutting attachment rotates at idle speed, let a service agent adjust it. Do not use the product until it is adjusted or repaired.
- Look out for thrown objects. Always use approved eye protection and keep away from the cutting attachment guard. Stones and other small objects can eject into your eyes and cause blindness or other injuries.
- Do not put the product down with the engine on unless you have it in clear view.
- Do not remove the cut material, or let other persons remove cut material, while the engine is on or the cutting equipment rotates, as this can result in serious injury.
- The bevel gear can get hot during use and may remain so for a while afterwards. You could get burnt if you touch it.
- Always stop the engine and make sure that the cutting equipment does not rotate before you remove material that is wound around the blade shaft or caught between the guard and the cutting attachment. The cutting equipment continues to rotate even after the throttle has been released. Ensure that the cutting attachment has stopped completely and disconnect the spark plug cap before you start to work on it.
- Be careful when you remove material from around the cutting equipment. The bevel gear gets hot during operation and can cause burn injuries.
- The exhaust fumes from the engine are hot and can contain sparks. Risk of fire. Be careful around dry and flammable material.
- Stop the engine before you move to a new work area. Always attach the transport guard before you move the equipment.
- Never use the product indoors or in spaces lacking proper ventilation. Exhaust fumes contain carbon monoxide, an odourless, poisonous and highly dangerous gas can result in death due to asphyxiation or carbon monoxide poisoning.
- Never allow children to use or be in the vicinity of the product. As the product is equipped with a spring-loaded stop switch and can be started by low speed and force on the starter handle, even small children under some circumstances can produce the force necessary to start the product. This can mean a risk of serious personal injury. Therefore remove the spark plug cap when the product is not under close supervision.
- Overexposure to vibration can lead to circulatory damage or nerve damage in persons who have poor circulation. Speak to your physician if you experience symptoms of overexposure to vibration. Such symptoms include numbness, loss of feeling, tingling, pricking, pain, loss of strength, changes in skin color or condition. These symptoms usually show in the fingers, hands or wrists. The risk increases at low temperatures.
- Check that the cutting equipment is correctly fitted and adjusted.
- If you encounter a situation where you are uncertain how to proceed you should ask an expert. Contact your dealer or your service workshop.

- Avoid all usage which you consider to be beyond your capability.
- Do not use the product unless you are able to call for help in the event of an accident.
- Using an incorrect cutting attachment or an incorrectly sharpened blade increases the risk of blade thrust.
- Products fitted with saw blades or grass blades can be thrown violently to the side when the blade comes into contact with a fixed object. This is called blade thrust. A blade thrust can be violent enough to cause the product and/or operator to be propelled in any direction, and possibly lose control of the product. Blade thrust can occur without warning if the product snags, stalls or binds. Blade thrust is more likely to occur in areas where it is difficult to see the material being cut.
- Avoid cutting with the area of the blade between the 12 o'clock and 3 o'clock positions. Because of the speed of rotation of the blade, blade thrust can occur if you attempt to cut thick stems with this area of the blade.
- Mufflers fitted with catalytic converters get very hot during use and remain so for some time after stopping. This also applies at idle speed. Contact can result in burns to the skin. Remember the risk of fire.
- Only use cutting attachments with the guards we recommend. Refer to *Accessories on page 26*.

To do a check of the throttle trigger lockout

The throttle trigger lockout locks the throttle trigger at the idle position to prevent accidental operation of the throttle trigger. When you release the handle of the throttle trigger and the throttle trigger lockout the two move back to their initial positions.

1. Push the throttle trigger lockout (A). Make sure that the throttle trigger (B) is released.

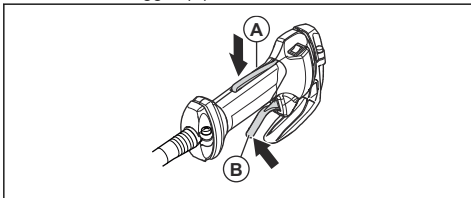

2. Make sure that the throttle trigger (B) is locked at the idle position when the throttle trigger lockout is released.

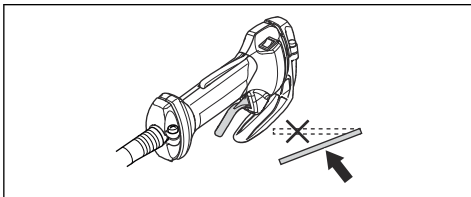

3. Push the throttle trigger lockout (A) and make sure that it goes back to its initial position when you release it.

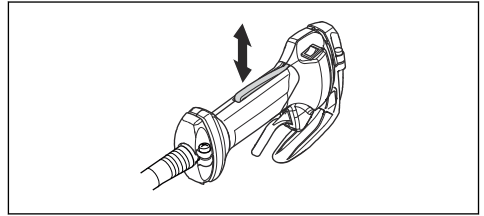

4. Make sure that the throttle trigger lockout (A) and the throttle trigger (B) move freely.

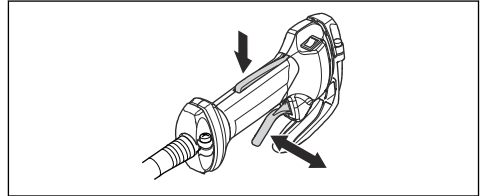

5. Start the product and apply full throttle. Refer to *To start the engine on page 17*
6. Release the throttle trigger (B) and make sure that the cutting attachment stops and stays stationary.



WARNING: If the cutting attachment moves when the throttle trigger is in the idle position, adjust the idle speed. Refer to *To adjust the idle speed on page 21*.

To do a check of the stop switch

1. Start the engine.
2. Move the stop switch to the stop position and make sure that the engine stops.

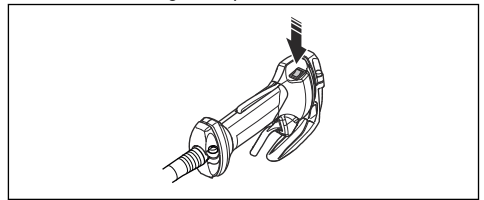

To do a check of the cutting attachment guard



WARNING: An incorrect or defective cutting attachment guard can cause serious injury. Refer to *Accessories on page 26*.



WARNING: Always use the recommended cutting attachment guard for the cutting attachment that you use. If an incorrect or defective cutting attachment guard is installed, this can cause serious injury. Refer to *Accessories on page 26*.

The cutting attachment guard prevents injuries from objects that eject in the direction of the operator. It also prevents injuries that occur if you touch the cutting attachment.

1. Do a visual check for damages, for example cracks.

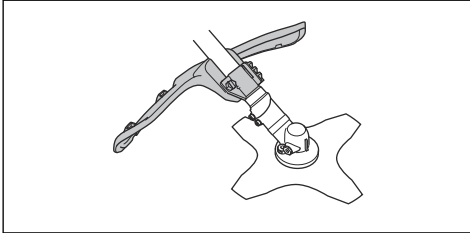

2. Replace the cutting attachment guard if it is damaged.

To do a check of the vibration damping system

The vibration damping system decreases vibration in the handles to a minimum which makes the operation easier.

1. Stop the engine.
2. Do a visual check for deformation and damage, for example cracks.
3. Make sure that the elements of the vibration damping system are attached correctly.

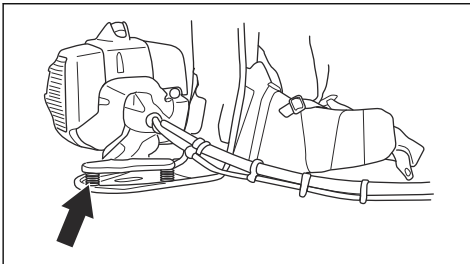

To do a check of the muffler



WARNING: Never use a product with a faulty muffler.



WARNING: Bear in mind that the exhaust fumes from the engine are hot and may contain sparks which can start a fire. Never start the product indoors or near combustible material!

The muffler keeps noise levels to a minimum and sends exhaust fumes away from the operator. For mufflers it is very important that you follow the instructions on how to check, maintain and service your product.

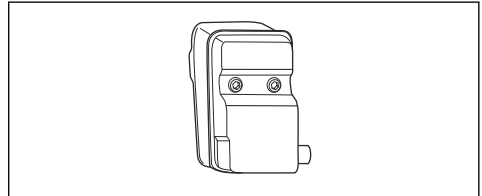

- Regularly check that the muffler is securely attached to the product.

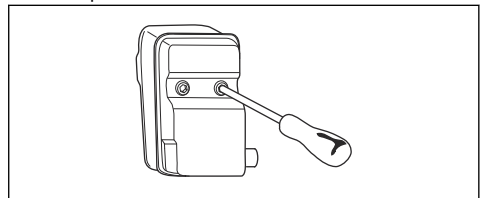

To attach and remove the locknut



WARNING: Stop the engine, use protective gloves and be careful around the sharp edges of the cutting attachment.

A locknut is used to attach some types of cutting attachments. The locknut has a left thread.

- To attach, tighten the locknut in the opposite direction to the direction of turning of the cutting attachment.
- To remove the locknut, loosen the locknut in the same direction as the cutting attachment rotates.

- To loosen and tighten the locknut, use a socket wrench with a long shaft. The arrow in the picture shows the area where you can operate the socket wrench.

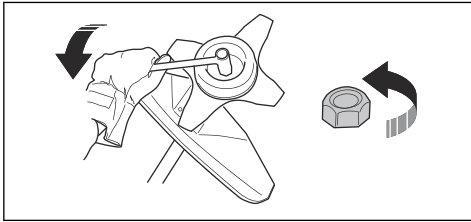

WARNING: When you loosen and tighten the locknut, there is a risk of injury from the blade. You must always make sure that the blade guard prevents injury to your hand when you do this.

Note: Make sure that you can not turn the locknut by hand. Replace the nut if the nylon lining does not have a resistance of a minimum of 1.5 Nm. The locknut must be replaced after it has been put on approximately 10 times.

Personal protective equipment



WARNING: Read the warning instructions that follow before you use the product.

- Always use approved personal protective equipment when you use the product. Personal protective equipment cannot fully prevent injury but it decreases the degree of injury if an accident does occur. Let your dealer help you select the right equipment.
- Use a protective helmet where there is a risk of falling objects.

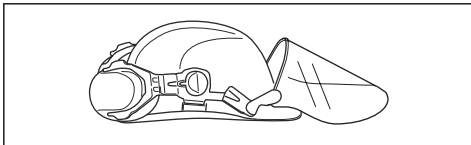

- Use approved hearing protection that provides adequate noise reduction. Long-term exposure to noise can result in permanent hearing impairment.

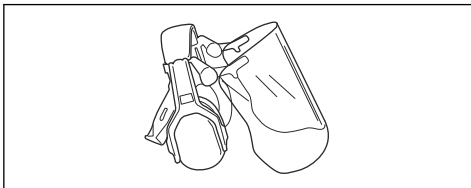

- Use approved eye protection. If you use a visor, you must also use approved protective goggles. Approved protective goggles must comply with the ANSI Z87.1 standard in the USAs or EN 166 in EU countries.

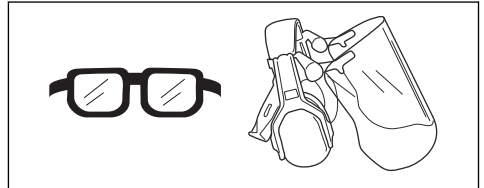

- Use gloves when necessary, for example when you attach, examine or clean the cutting equipment.

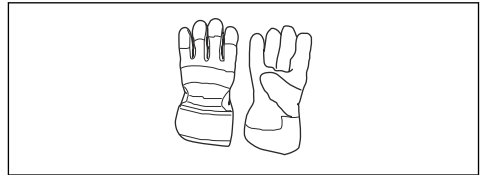

- Use protective boots with steel toes and non-slip soles.



- Use clothing made of a strong fabric. Always use heavy, long pants and long sleeves. Do not use loose clothing that can catch on twigs and branches. Do not wear jewelry, short pants, sandals or go with bare feet. Put your hair up safely above shoulder level.
- Keep first aid equipment close at hand.



Harness quick release



WARNING: Do not use the harness if the quick release function is defective. Make sure that the quick release function operates correctly when you adjust the product.



WARNING: Make sure that the product is attached safely to the harness when you operate the product. If not, you can not control the product safely and result in injury to you or others.

The quick release function is at the front of the harness. The harness straps must always stay at the correct position.

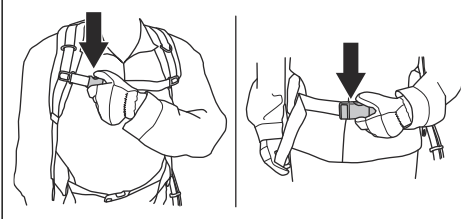

In an emergency, the quick release function helps you to safely release from the product.

Cutting attachment



WARNING: The cutting attachment must not rotate when you do work on it. Make sure that the engine has stopped. Remove the spark plug cap before you do work on the cutting attachment.



WARNING: Make sure that the cutting attachment is not damaged. A damaged cutting attachment can cause accidents. Replace a damaged cutting attachment.



WARNING: Use the correct cutting attachment. Only use the cutting attachment with the guards we recommend, refer to *Accessories on page 26*.

Cutting equipment

- Use the blades and grass knives to cut coarse grass.

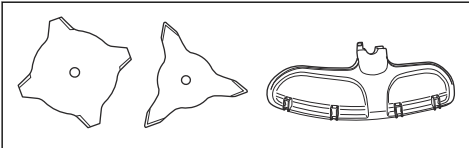

- Use the trimmer head to cut grass.

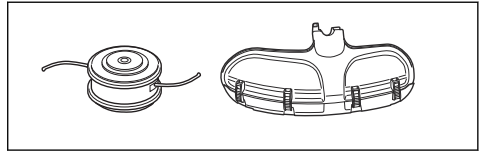

- An incorrectly sharpened or damaged blade increases the risk of accidents. Keep the teeth of the blade correctly sharpened. Follow the instructions in *To sharpen the grass knife and grass blade on page 23* and use the recommended file gauge.

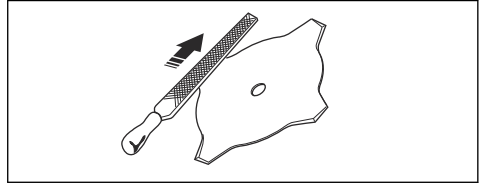

- Examine the cutting attachment for damage and cracks. Replace the damaged cutting attachment.
- Only use cutting attachments with recommended guards. See *Accessories on page 26*.

Trimmer head



WARNING: Always make sure the trimmer line is wound tightly and evenly around the drum to prevent harmful vibration.



- Only use recommended trimmer heads and trimmer lines.
- Only use recommended cutting attachments.
- Smaller machines requires small trimmer heads and vice versa.
- The length of the trimmer line is important. A longer trimmer line requires greater engine power than a shorter trimmer line of the same diameter.
- Make sure that the cutter on the trimmer guard is intact. This cuts the trimmer line to the correct length.
- Soak the trimmer line in water for a couple of days before use to increase the life length.

Safety instructions for maintenance



WARNING: Read the warning instructions that follow before you use the product.

- Stop the engine, make sure that the cutting attachment stops and let the product cool down before you do the maintenance.
- Disconnect the spark plug cap before you do the maintenance.

- The exhaust fumes from the engine contain carbon monoxide, an odourless, poisonous and very dangerous gas that can cause death. Do not run the product indoors or in closed spaces.
- The exhaust fumes from the engine are hot and can contain sparks. Do not run the product indoors or near flammable material.
- Accessories and changes to the product that are not approved by the manufacturer, can cause serious injury or death. Do not change the product. Always use original accessories.
- If the maintenance is not done correctly and regularly, there is an increased risk of injury and damage to the product.
- Only do the maintenance as this operator's manual recommends. Let an approved Husqvarna service agent do all other servicing.
- Let an approved Husqvarna service agent do servicing on the product regularly.
- Replace damaged, worn or broken parts.

Fuel safety



WARNING: Read the warning instructions that follow before you use the product.

- Do not mix the fuel indoor or near a heat source.
- Do not start the product if there is fuel or engine oil on the product. Remove the unwanted fuel/oil and let the product dry. Remove unwanted fuel from the product.
- If you spill fuel on your clothing, change clothing immediately.
- Do not get fuel on your body, it can cause injury. If you get fuel on your body, use a soap and water to remove the fuel.
- Do not start the engine if you spill oil or fuel on the product or on your body.
- Do not start the product if the engine has a leak. Examine the engine for leaks regularly.
- Be careful with fuel. Fuel is flammable and the fumes are explosive and can cause injuries or death.
- Do not breathe in the fuel fumes, it can cause injury. Make sure that there is a sufficient airflow.
- Do not smoke near the fuel or the engine.
- Do not put warm objects near the fuel or the engine.
- Do not add the fuel when the engine is on.
- Make sure that the engine is cool before you refuel.
- Before you refuel, open the fuel tank cap slowly and release the pressure carefully.
- Do not add fuel to the engine in an indoor area. Not sufficient airflow can cause injury or death because of asphyxiation or carbon monoxide.
- Tighten the fuel tank cap carefully or a fire can occur.
- Move the product at a minimum of 3 m (10 ft) from the position where you filled the tank before a start.
- Do not put too much fuel in the fuel tank.
- Make sure that a leak cannot occur when you move the product or fuel container.
- Do not put the product or a fuel container where there is an open flame, spark or pilot light. Make sure that the storage area does not contain an open flame.
- Only use approved containers when you move the fuel or put the fuel into storage.
- Empty the fuel tank before long-term storage. Obey the local law on where to dispose fuel.
- Clean the product before long-term storage.
- Remove the spark plug cap before you put the product into storage to make sure that the engine does not start accidentally.

Assembly

Introduction



WARNING: Before you assemble the product, you must read and understand the safety chapter.



WARNING: Remove the spark plug cable from the spark plug before you assemble the product.

To assemble the flexible drive shaft

1. Remove the 2 screws at the shaft coupling.

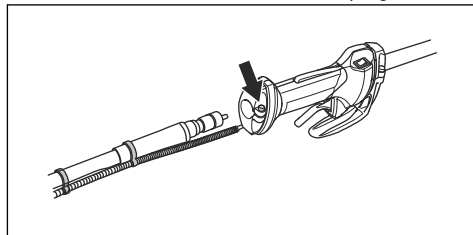

2. Put the flexible drive shaft through the loops at the wire harness.

3. Turn and push the flexible drive shaft at the same time to connect it.
4. Tighten the 2 screws.
5. Assemble the drive shaft sleeve in the clutch cover. Turn and push the drive shaft at the same time to connect it.

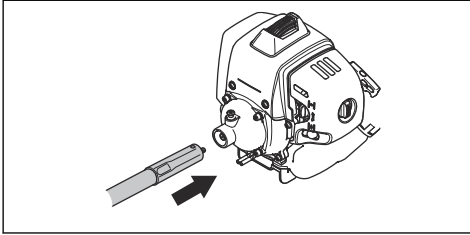

6. Make sure that the locking pin goes back to its initial position.

To connect the throttle cable and the stop switch wires

1. Open the cover.
2. Connect the throttle wire from the wire harness (A) and the throttle wire (B) from the engine in the cover.

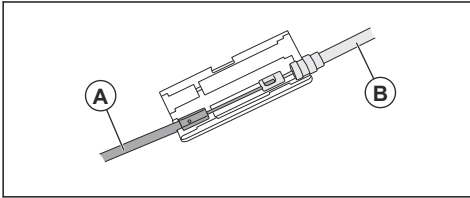

3. Close the cover.
4. Connect the stop switch wires into the related connectors from the engine.

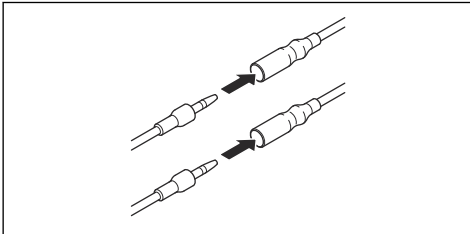

To assemble the loop handle

1. Put the loop handle on the shaft.

2. Attach the spacer into the slot in the loop handle. Attach the nut and the screw. Do not tighten fully.

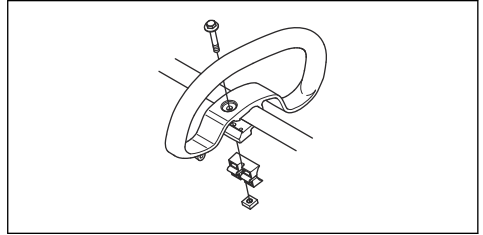

3. Adjust the product to an applicable work position.
4. Tighten the nut and the screw.

To assemble the J-handle



WARNING: Use the J-handle with grass blades/grass cutters or trimmer heads/plastic blades. Do not use saw blades or clearing blades with the J-handle.

1. Attach the J-handle to the loop handle with 3 screws.

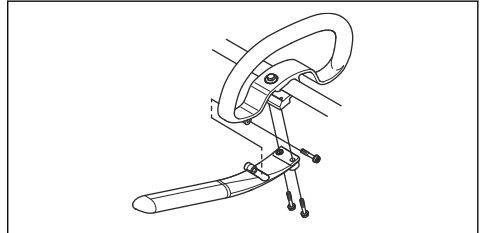

2. Adjust the product to an applicable work position.
3. Tighten the screws.

To assemble the cutting equipment

The cutting equipment includes a cutting attachment and a cutting attachment guard.



WARNING: Use protective gloves.



WARNING: Always use the cutting attachment guard that is recommended for the cutting attachment. See *Accessories on page 26*.



WARNING: An incorrectly attached cutting attachment can result in injury or death.

To attach the guard extension



CAUTION: Use the guard extension when you use a trimmer head/plastic blade. Do not use the guard extension when you use a grass blade.

1. Put the guard extension in the groove of the cutting attachment guard.

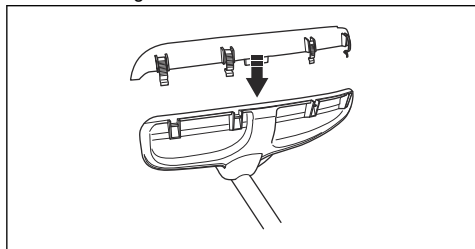

2. Put the guard extension into position on the cutting attachment guard with the 4 locking hooks.

To remove the guard extension

- Release the locking hooks with the spark plug wrench.

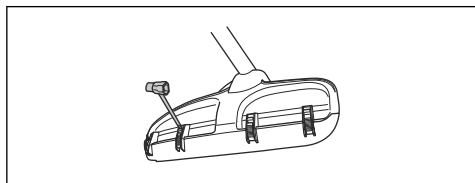

To attach the grass blade and the grass blade guard/combination guard

1. Put the blade guard/combination guard (A) onto the shaft and tighten the bolt to attach it.

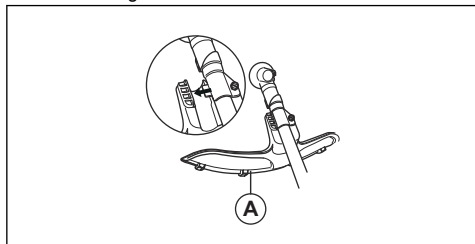

2. Make sure that the guard extension is removed.
3. Turn the output shaft to align one of the holes in the drive disc (B) with the related hole in the gear housing.
4. Put the locking pin (C) in the hole to lock the shaft.

5. Put the grass blade (D), the support cup (E) and the support flange (F) on the output shaft.

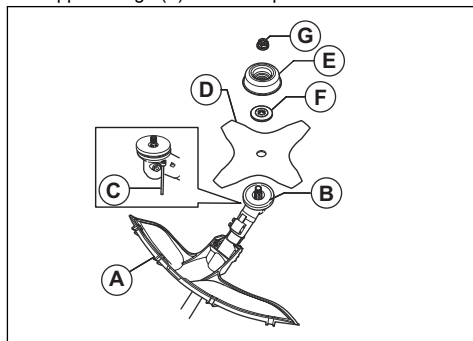

6. Make sure that the drive disc and support flange engages correctly in the centre hole of the grass blade.

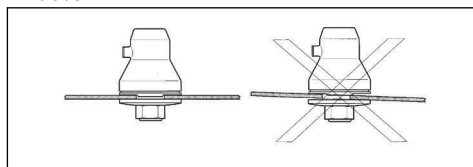

7. Attach the nut (G).
8. Tighten the nut with the socket wrench. Hold the shaft of the socket wrench near the blade guard. Tighten in the opposite direction to how the cutting attachment rotates. Tighten it to a torque of 35-50 Nm.

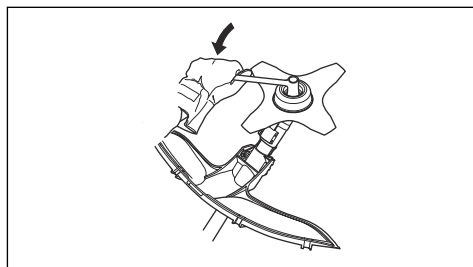

To assemble and disassemble the cutting attachment guard and trimmer head



CAUTION: Make sure that the guard extension is attached.

1. Attach the correct cutting attachment guard (A) for the trimmer head. Refer to *Accessories on page 26*.
2. Put the cutting attachment guard onto the fitting on the shaft.
3. Attach the cutting attachment guard with the bolt.
4. Install the drive disc (B) on the output shaft.

- Turn the output shaft until one of the holes in the drive disc aligns with the related hole in the gear housing.
- Put the locking pin (C) in the hole to lock the shaft.

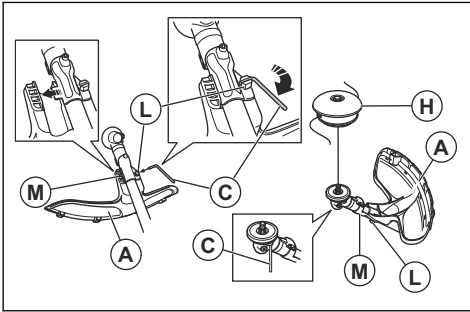

- Turn the trimmer head /plastic blades (H) in the opposite direction from which the trimmer head/ plastic blades rotate.

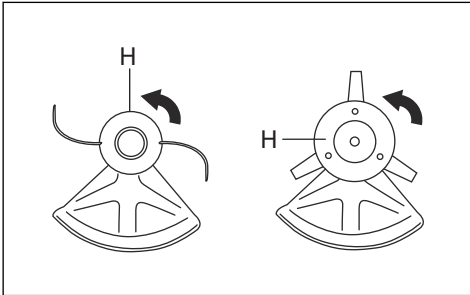

- To disassemble, follow the instructions in the opposite sequence.

To install the transport guard

- Install the blade in the transport guard (A).
- Put the two fasteners (B) into the slots (C) to attach the transport guard.

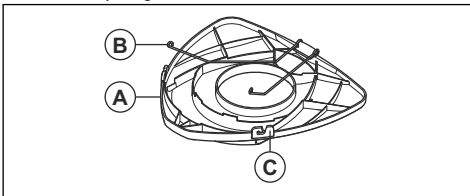

To adjust the backplate height

- Loosen the 2 fasteners that hold the backplate.

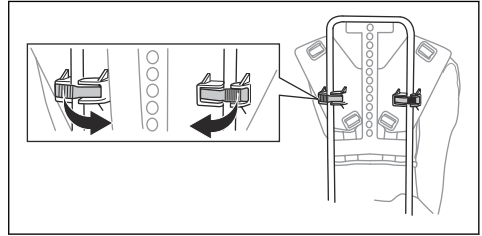

- Loosen the backplate from the frame on 1 side.

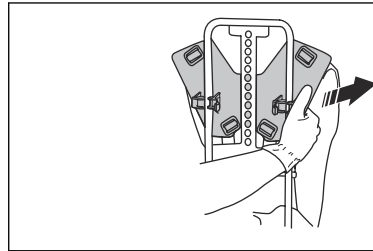

- Adjust the backplate to the correct height. Make sure that the pin aligns with 1 of the holes on the frame.

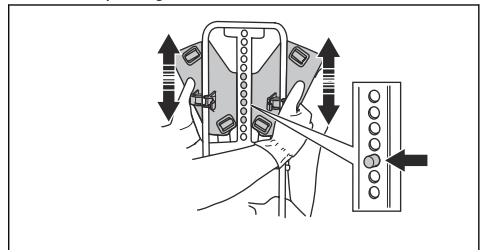

To adjust the harness

- Put on the harness of the product.
- Tighten the hip strap tightly. Make sure that the hip strap aligns with the hip.

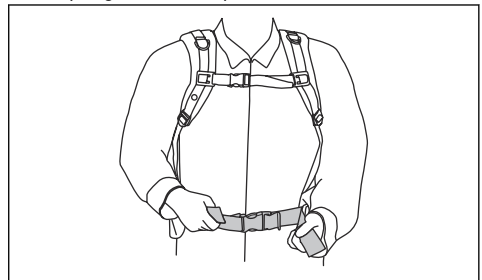

3. Tighten the chest strap.

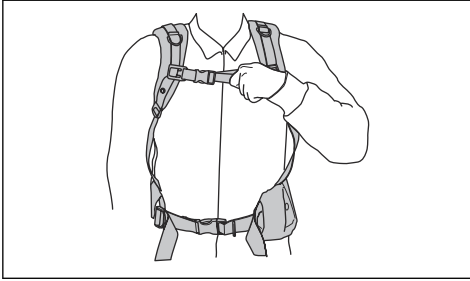

4. Adjust the chest strap vertically. Make sure that the chest strap is tight against your body.

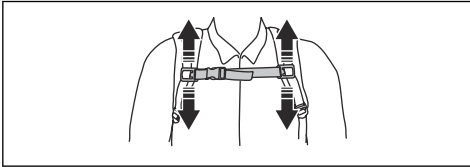

5. Adjust the shoulder strap until the weight is equal on your shoulders.

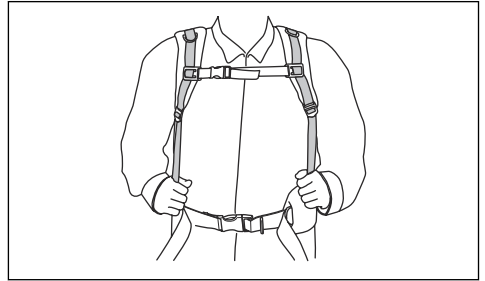

Operation

Introduction



WARNING: Before you operate the product, you must read and understand the safety chapter.

Before you operate the product

- Examine the work area to make sure that you know the type of terrain, the slope of the ground and if there are obstacles such as stones, branches and ditches.
- Do an overhaul inspection of the product.
- Do the safety inspections, maintenance and servicing that are given in this manual.
- Make sure that all covers, guards, handles and the cutting equipment are correctly attached and not damaged.

- Make sure that there are no cracks at the bottom of the grass blade teeth or by the center hole of the blade. Replace the blade if it is damaged.

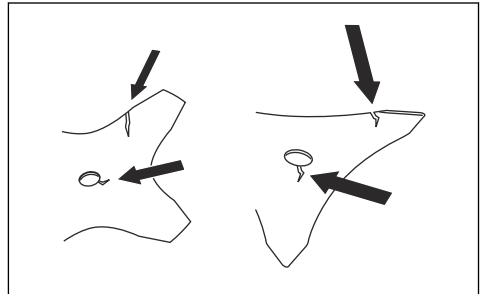

- Examine the support flange for cracks. Replace the support flange if it is damaged.

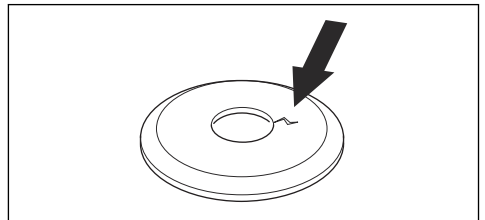

- Make sure that the locknut can not be removed by hand. If you can remove it by hand, it does not lock

the cutting attachment sufficiently and you must replace it.

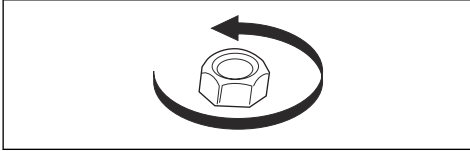

- Examine the blade guard for damages or cracks. Replace the blade guard if it has been hit or if it has cracks.

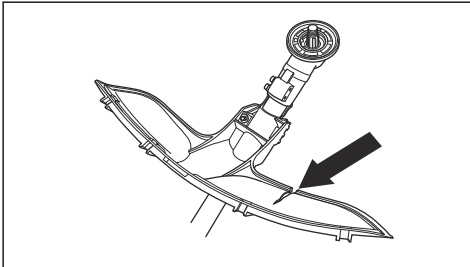

- Examine the trimmer head and cutting attachment guard for damages or cracks. Replace the trimmer head and cutting attachment guard if they have been hit or if they have cracks.

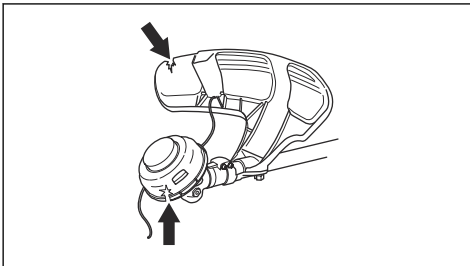

Fuel

This product has a two-stroke engine.



CAUTION: Incorrect type of fuel can result in engine damage. Use a mixture of gasoline and two-stroke oil.

Gasoline



CAUTION: Always use a quality gasoline/oil mixture of at least 90 octane (RON). There is a risk that use of lower octane grade causes knocking. This gives rise to high engine temperature, which can result in serious engine damage.



CAUTION: If your product is equipped with a catalytic converter use a good quality unleaded gasoline/oil mixture. Leaded gasoline will destroy the catalytic converter.

- Use low-emission gasoline, also known as alkylate gasoline, if it is available.

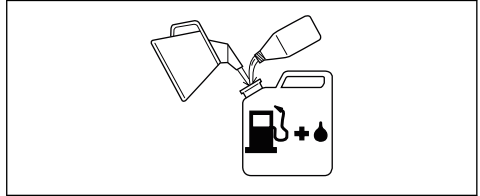

- Ethanol blended fuel, E10 may be used (max 10% ethanol blend). Using ethanol blends higher than E10 will cause lean running condition which can damage the engine.
- We recommend a higher octane rating when you do work at continuous high speed.

Husqvarna alkylate fuel

We recommend you to use Husqvarna alkylate fuel for best performance. The fuel contains less dangerous material compared to regular fuel, which decreases dangerous exhaust fumes. The fuel gives a low quantity of dangerous remainings when it is combusted, which keeps the components of the engine more clean. This extends the life of the engine. Husqvarna alkylate fuel is not available in all markets.

Two-stroke oil



CAUTION: Unsatisfactory oil quality and/or incorrect oil/fuel ratio can damage the product and decrease the life time of catalytic converters.



CAUTION: Do not use two-stroke oil for water-cooled outboard engines, also referred to as outboard oil.



CAUTION: Do not use oil for four-stroke engines.

- For best results and performance use Husqvarna two-stroke oil.
- If Husqvarna two-stroke oil is not available, use a different two-stroke oil of good quality for air-cooled engines. Speak to your servicing dealer to select the correct oil.

Gasoline, l	Two-stroke oil, l
	2% (50:1)

5	0.10
10	0.20
15	0.30
20	0.40

To mix gasoline and two-stroke oil



CAUTION: There is a risk that small errors influence the ratio of the mixture drastically when you mix small quantities of fuel. Carefully measure the quantity of oil to be mixed to make sure that you get the correct mixture.

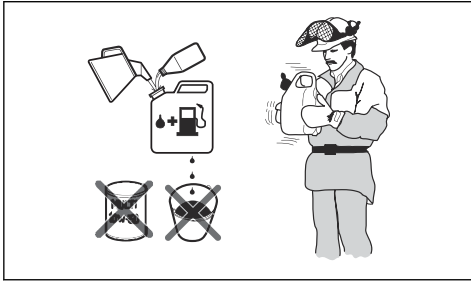

1. Fill half the quantity of the gasoline to be used.
2. Add the full quantity of oil and mix (shake) the fuel mixture.
3. Add the remaining quantity of gasoline.
4. Carefully mix (shake) the fuel mixture and fill the fuel tank of the product.
5. Empty and clean the fuel tank if you do not use the product for some time.

Note: Do not mix fuel for more than 1 month at a time and always mix gasoline and oil in a clean container intended for fuel.

To fill the fuel tank

1. Clean the area around the fuel tank cap.
2. Shake the container and make sure that the fuel is fully mixed. Use a fuel container with an anti-spill valve.
3. Fill the fuel tank.
4. Tighten the fuel tank cap carefully.
5. Move the product 3 m (10 ft) or more away from the refueling area and fuel source before starting.

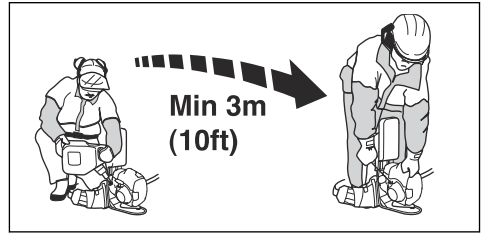

CAUTION: Contamination in the tanks causes malfunction. Clean the fuel tank and chain oil tank regularly and replace the fuel filter one time a year or more.

Work position

- Hold the product with 2 hands.
- Hold the product on the right side of your body.
- Keep the cutting attachment below waist level.
- Always keep the product attached to the harness.
- Keep body parts away from the hot surfaces.
- Keep body parts away from the cutting attachment.

To start the engine



WARNING: Keep the safety distance of 15 m/49 ft when the engine starts. There is a risk that the cutting attachment starts to rotate.

1. Set the stop switch to the start position.
2. Set the choke control in the choke position.

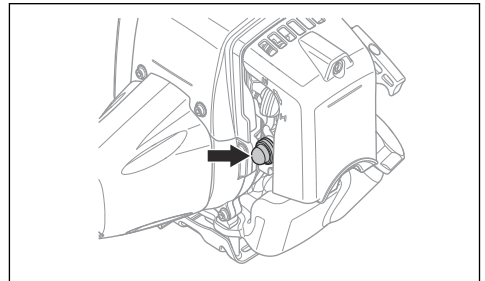

- Push the air purge bulb until the bulb starts to fill with fuel.

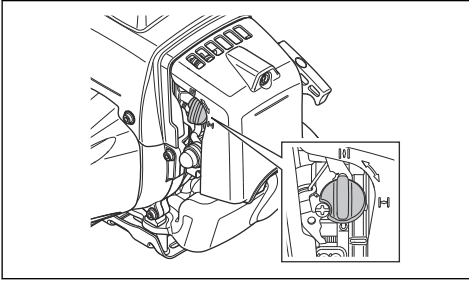

- Hold the body of the product on the ground with your left hand. Do not put your feet on the product.

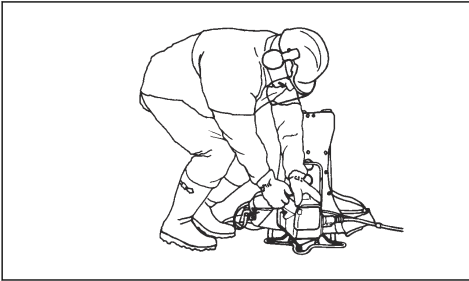

- Pull the starter rope handle slowly until you feel some resistance, then pull the starter rope handle with force.



WARNING: Do not wind the starter rope around your hand.

- Continue to pull the starter rope handle until the engine starts.



CAUTION: Do not pull the starter rope until it stops. Do not let go of the starter rope when it is fully extended. Release the starter rope slowly. Risk of damage to the product.

- When the engine starts, put the choke control in the run position and apply full throttle. The throttle trigger automatically disengages from the start position.
- Make sure that the engine runs smoothly.



WARNING: Keep body parts away from the spark plug cap to prevent burn injuries. Risk of burn injuries. Do not use the product with a damaged spark plug cap. Risk of electrical shock.

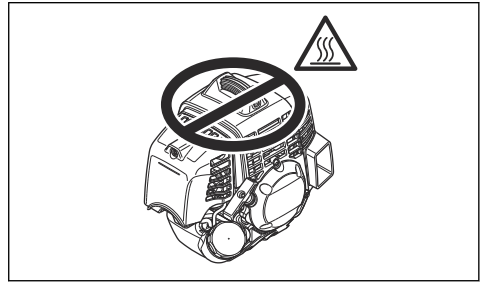

To stop the product

- Move the stop switch to the stop position to stop the engine.

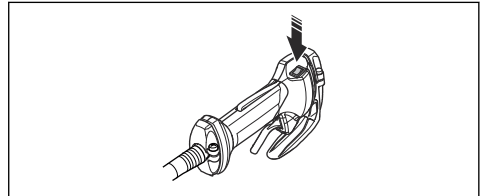

General work instructions



WARNING: Be careful when you cut a tree that is in tension. It can spring back to its normal position before or after the cut and hit you or the product, and cause injury.

- Clear an open space at one end of the work area, and start the work from there.
- Move in a regular pattern across the work area.

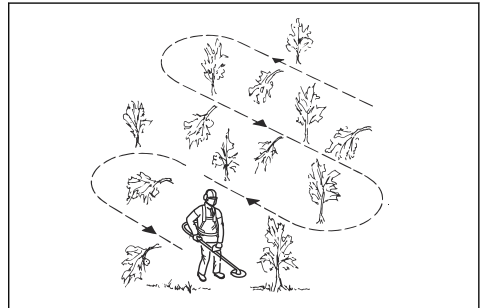

- Move the product fully to the left and right, to clear a width of 4–5 m on each turn.
- Clear a length of 75 m before you turn and go back. Move the fuel can along with you as you continue.
- Move in a direction where you do not go across ditches and obstacles more than necessary.

- Move in a direction where the wind makes the cut vegetation fall in the cleared area.

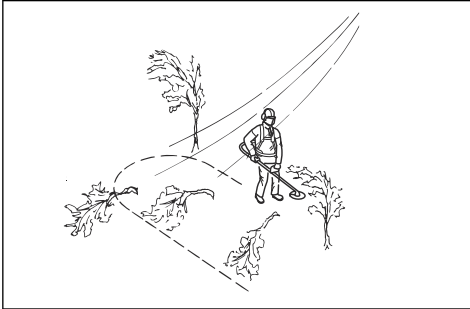

- Move along slopes, not up and down.

Grass clearing with a grass blade



CAUTION: Do not use grass blades and grass knives on wood. Use grass blades and grass knives for long or heavy grass only.

- Move the product from side to side.
- Start the movement from right to left when you cut. Move the product to the right before you cut again.
- Cut with the left side of the grass blade.

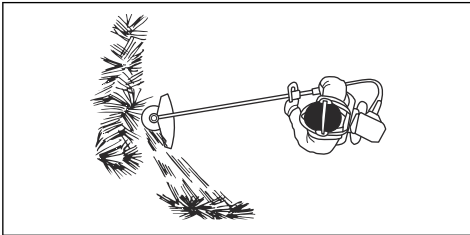

- Tilt the grass blade to the left to make the grass fall in a line. This makes it easy to collect the grass.
- Keep a stable position with your feet apart.
- Move forward after each right movement and make sure that you have a stable position again before you cut again.
- Keep the support cup with a light pressure against the ground to make sure that the grass blade does not hit the ground.
- Obey these instructions to decrease the risk that cut material winds around the grass blade:
 - a) Apply full throttle.
 - b) Do not move the grass blade through cut material when you move the product from left to right.
- Before you collect the cut material, stop the engine and remove the product from the harness. Put the product down on the ground.

Grass trimming with a trimmer head

To trim the grass

1. Hold the trimmer head immediately above the ground at an angle. Do not push the trimmer line into the grass.

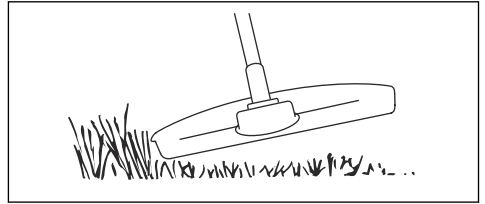

2. Decrease the length of the trimmer line by 10-12 cm / 4-4.75 in.
3. Decrease the engine speed to decrease the risk of damage to plants.
4. Use 80 % throttle when you cut grass near objects.



To clear grass with a grass blade

1. Grass blades and grass cutters must not be used on woody stems.
2. A grass blade is used for all types of tall or coarse grass.
3. The grass is cut down with a sideways, swinging movement, where the movement from right-to-left is the clearing stroke and the movement from left-to-right is the return stroke. Let the left-hand side of the blade (between 8 and 12 o'clock) do the cutting.
4. If the blade is angled to the left when clearing grass, the grass will collect in a line, which makes it easier to collect, e.g. by raking.
5. Try to work rhythmically. Stand firmly with your feet apart. Move forward after the return stroke and stand firmly again.
6. Let the support cup rest lightly against the ground. It is used to protect the blade from hitting the ground.
7. Reduce the risk of material wrapping around the blade by always work at full throttle and avoid the previously cut material during the return stroke.
8. Stop the engine, unclip the harness and place the machine on the ground before you start to collect the cut material.

To cut the grass

1. Make sure that the trimmer line is parallel to the ground when you cut the grass.

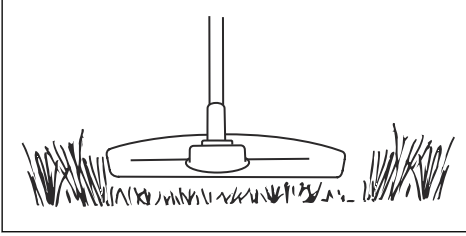

2. Do not push the trimmer head to the ground. This can cause damage to the product.
3. Move the product from side to side when you cut grass. Use full speed.

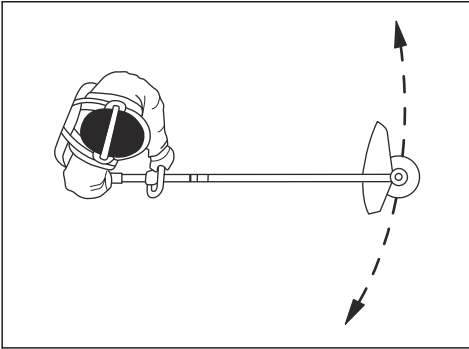

To sweep the grass

The airflow from the rotating trimmer line can be used to remove cut grass from an area.

1. Hold the trimmer head and the trimmer line parallel to the ground and above the ground.
2. Apply full throttle.
3. Move the trimmer head from side to side and sweep the grass.



WARNING: Clean the trimmer head cover each time you assemble new trimmer line to prevent unbalance and vibrations in the handles. Also do a check of the other parts of the trimmer head and clean it if necessary.

Maintenance

Introduction



WARNING: Before you do maintenance, you must read and understand the safety chapter.

For all servicing and repair work on the product, special training is necessary. We guarantee the availability of

professional repairs and servicing. If your dealer is not a service agent, speak to them for information about the nearest service agent.

Maintenance schedule

Maintenance	Daily	Weekly	Monthly
Clean the external surface.	X		
Examine the harness for damages.	X		
Do a check of the handle and the handlebar to make sure that they are attached correctly and not damaged.	X		
Make sure that the throttle trigger lock and the throttle operates correctly.	X		
Do a check of the stop switch to make sure that it operates correctly.	X		
Make sure that the cutting attachment does not rotate at idle speed.	X		

Maintenance	Daily	Weekly	Monthly
Clean the air filter. Replace if it is necessary.	X		
Make sure that the blade is sharp and put correctly in the center, look for cracks. If the blade is not in the center correctly, it can cause damage to the product.	X		
Examine the cutting attachment guard for damages and cracks. Replace it if it is damaged.	X		
Examine the trimmer head for damages and cracks. Replace it if it is damaged.	X		
Make sure that the screws and nuts are tight.	X		
Examine the engine, the fuel tank and the fuel lines for leaks.	X		
Examine the transport guard. Make sure that the blade is not damaged and that the transport guard can be attached correctly.	X		
Clean the cooling system.		X	
Examine the starter and the starter rope for damages.		X	
Examine the vibration damping units for damages and cracks.		X	
Clean the external surface part of the spark plug. Remove it and do a check of the electrode gap. Adjust the electrode gap to the correct distance (refer to <i>Technical data on page 25</i>) or replace the spark plug. Make sure that the spark plug has a suppressor.		X	
Clean the external surface of the carburetor and the area around it.		X	
Do a check of the bevel gear to make sure that it is filled $\frac{3}{4}$ with lubricant. Use special grease to fill if it is necessary.		X	
Clean or replace the spark arrestor mesh on the muffler.		X	
Do a check of the fuel filter for contamination and the fuel hose for cracks or other defects. Replace if it is necessary.			X
Do a check of all cables and connections.			X
Do a check of the clutch, clutch springs and the clutch drum for wear. If it is necessary to replace 1 or more of these units, speak to your servicing dealer.			X
Replace the spark plug. Make sure that the spark plug has a suppressor.			X
Examine and clean the spark arrestor mesh on the muffler.			X

To adjust the idle speed



WARNING: Read the warning instructions in the safety chapter before you start the product. Refer to *Safety on page 4*.



WARNING: If the cutting attachment rotates when the engine is at idle speed the idle adjustment screw T must be turned counterclockwise until the cutting attachment stops.

1. Make sure that the air filter is clean.
2. Make sure that the air filter cover is in position.
3. Get the idle adjustment screw T.

4. Turn the idle adjustment screw T clockwise until the cutting attachment starts to rotate

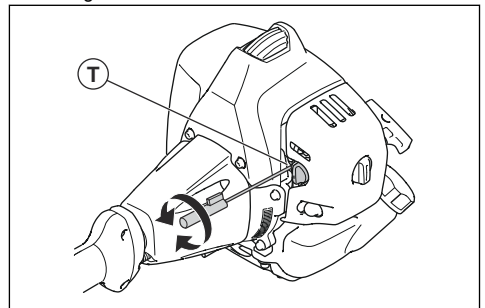

- Turn the screw counterclockwise until the cutting attachment stops.



WARNING: If the cutting attachment does not stop when you adjust the idle speed, turn to your nearest servicing dealer. Do not use the product until it is correctly adjusted or repaired.

- Make sure the engine runs smoothly in all positions.

To clean the cooling system



CAUTION: A dirty or blocked cooling system can make the product too hot, which can cause damage to the product.

The cooling system includes:

- The cooling fins on the cylinder (A).
- The air intake (B).

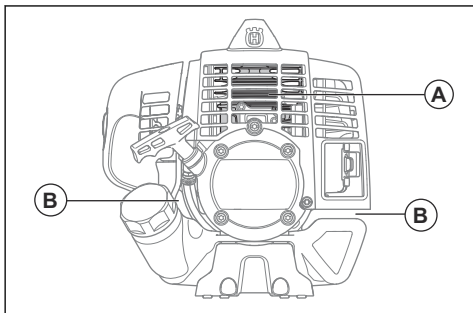

- Make sure that the cooling system is not dirty or blocked.
- Clean the cooling system with a brush weekly or more frequently if it is necessary.

To clean the air filter



CAUTION: An air filter that is damaged must always be replaced.

If you use an air filter for a long time, it cannot be fully cleaned. Replace the air filter with a new one at regular intervals.

- Remove the air filter cover and remove the air filter.

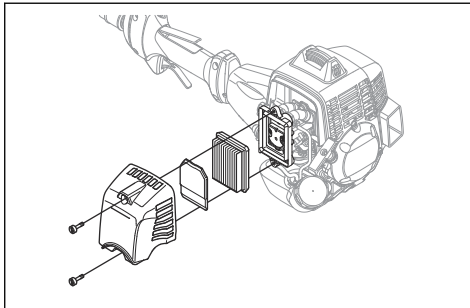

- Clean the air filter with compressed air.
- Clean the inner surface of the filter cover. Use air or a brush.
- Make sure that the filter is dry.

Fuel filter

When the engine runs short of fuel, make sure that the air hole in the fuel tank cap and the fuel filter (A) are clean.

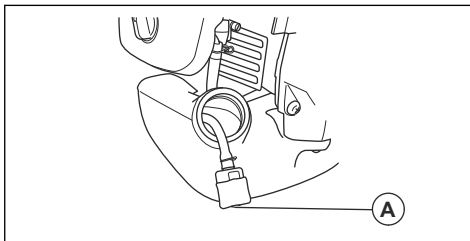

Bevel gear

The bevel gear is filled to $\frac{3}{4}$ with grease at the factory. Before you use the product, make sure that the grease level has not changed. Use Husqvarna special grease if it is necessary to fill up. Do not replace the grease in the bevel gear. Let servicing personnel do the repair of the bevel gear.

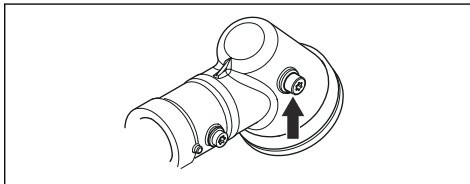

To examine the spark plug



CAUTION: Always use the recommended spark plug type. Incorrect spark plug type can cause damage to the product.

- Examine the spark plug if the engine is low on power, is not easy to start or does not operate correctly at idle speed.
- To decrease the risk of unwanted material on the spark plug electrodes, obey these instructions:
 - a) Make sure that the idle speed is correctly adjusted.
 - b) Make sure that the fuel mixture is correct.
 - c) Make sure that the air filter is clean.
- If the spark plug is dirty, clean it and make sure that the electrode gap is correct, refer to *Technical data on page 25*.

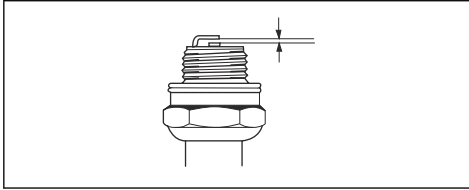

- Replace the spark plug if it is necessary.

To adjust the engine

Follow these instructions if the engine does not operate correctly.

1. Attach an approved cutting attachment, see *Accessories on page 26*.
2. Start the engine.
3. Operate the product in usual conditions for 3 minutes.
4. Lift the cutting attachment in the air and apply full throttle for 30 seconds. If a trimmer head is used, make sure that the trimmer line is cut to correct length by the guard knife.

Note: Do not cut grass or branches during this step.

5. Operate the product in usual conditions to make sure that the engine operates correctly.
6. If the engine does not operate correctly, do step 4 and 5 again 3 times.
7. Let your Husqvarna dealer adjust/repair the product if the engine does not operate correctly after you have done all these steps.

To sharpen the grass knife and grass blade



WARNING: Stop the engine. Use protective gloves.

- To sharpen the grass knife or grass blade correctly, refer to the instructions that come with the cutting attachment.
- Sharpen all edges equally to keep the balance.

- Use a single-cut flat file.

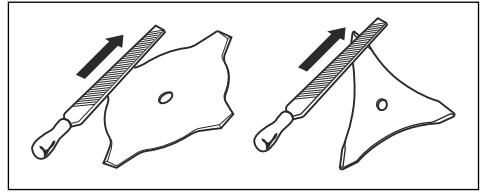

WARNING: Always discard a blade that is damaged. Do not try to make a bent or twisted blade straight and use it again.

To lubricate the flexible drive shaft

1. Pull up the knob and remove the drive shaft sleeve from the clutch cover.

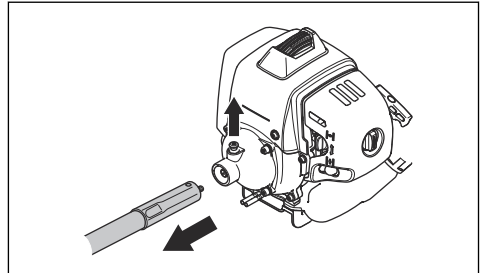

- a) Shake or pull the drive shaft out of the drive shaft sleeve.

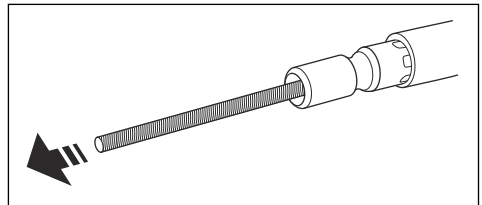

2. Lubricate the drive shaft.

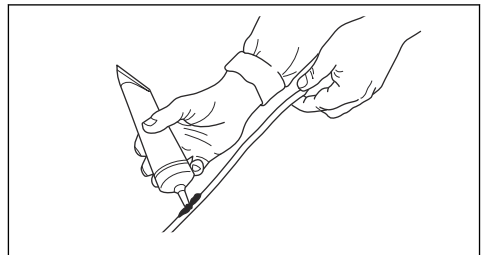

3. Push and turn the drive shaft at the same time to put it back in the drive shaft sleeve. Keep approximately 10 mm / 0.40 in. of the drive shaft outside the edge of the drive shaft sleeve.

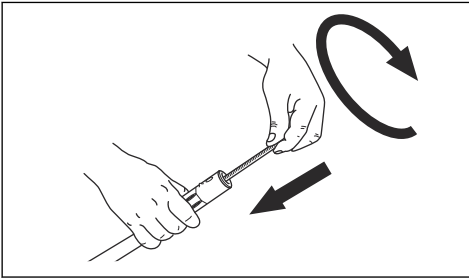

4. Align the hole in the drive shaft sleeve with the knob on the clutch cover.

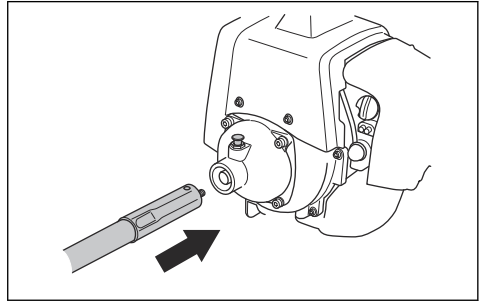

5. Push and turn the drive shaft at the same time to connect it.

Troubleshooting

The engine does not start

Check	Possible cause	Procedure
Stop switch.	The stop switch is in the stop position.	Let an approved service agent replace the stop switch.
Starter pawls.	The starter pawls cannot move freely.	Remove the starter cover and clean around the starter pawls. See <i>Product overview on page 2</i> . Let an approved service agent help you.
Fuel tank.	Incorrect fuel type.	Drain the fuel tank and fill with correct fuel.
Spark plug.	The spark plug is dirty or wet.	Make sure that the spark plug is dry and clean.
	The spark plug electrode gap is incorrect.	Clean the spark plug. Make sure that the electrode gap is correct. Make sure that the spark plug has a suppressor. Refer to technical data for correct electrode gap.
	The spark plug is loose.	Tighten the spark plug.

The engine starts but stops again

Check	Possible cause	Procedure
Fuel tank	Incorrect fuel type.	Empty the fuel tank and fill it with correct fuel.

Check	Possible cause	Procedure
Air filter	The air filter is clogged.	Clean the air filter.

Transportation, storage and disposal

Transportation and storage

- Always allow the product to cool down before storage.
- For storage and transportation of the product and fuel, make sure that there are no leaks or fumes. Sparks or open flames, for example from electrical devices or boilers, can start a fire.
- Always use approved containers for storage and transportation of fuel.
- Empty the fuel before transportation or before long-term storage. Discard the fuel at an applicable disposal location.
- Attach the transport guard during transportation and storage.
- Remove the spark plug cap from the spark plug.
- Attach the product during transportation. Make sure that it cannot move.
- Clean and do servicing on the product before long-term storage.

Technical data

Technical data

	553RBX
Engine	
Cylinder displacement, cm ³	50.6
Idle speed, rpm	2800
Recommended max. speed, rpm	13000
Speed of output shaft, rpm	9285
Max. engine output, according to ISO 8893, kW/hp @ rpm	2.3/ 3.1 @ 9500
Catalytic converter muffler	No
Ignition system	
Spark plug	NGK CMR7H
Electrode gap, mm	0.6-0.7
Fuel and lubrication system	
Fuel tank capacity, l/cm ³	0.8/800
Weight	
Without fuel, cutting attachment and guard, kg	12.1

	553RBX
Noise emissions¹	
Sound power level, measured dB(A)	115
Sound power level, guaranteed L _{WA} dB(A)	118
Noise levels²	
Equivalent sound pressure level at the operator's ear, measured according to EN ISO 11806 and ISO 22868, dB(A), min./max.	
Equipped with trimmer head (original)	103
Equipped with grass blade (original)	102
Vibration levels³	
Equivalent vibration levels (a _{hv,eq}) at handles, measured according to EN ISO 11806 and ISO 22867, m/s ²	
Equipped with trimmer head, left/right	3.3 / 2.7
Equipped with grass blade (original)	5.3 / 3.4

Accessories

Accessories

Approved accessories	Accessory type	Cutting attachment guard, art. no.
Grass blade/grass cutter	Multi 300-3 (Ø 300, 3 teeth)	537 33 16-03
	Multi 255-3 (Ø 255, 3 teeth)	537 33 16-03
	Multi 275-4 (Ø 275, 4 teeth)	537 33 16-03
	Multi 330-2 (Ø 330, 2 teeth)	537 33 16-03
Plastic blades	Tricut Ø 300 mm (Separate blades have part number 531 01 77-15)	537 33 16-03
Trimmer head	T35, T35X (Ø 2.4 - 3.0 mm cord)	537 33 16-03
	S35 (Ø 2.4 - 3.0 mm cord)	537 33 16-03
	T45x (Ø 2.7 - 3.3 mm cord)	537 33 16-03
	S II	537 33 16-03

¹ Noise emissions in the environment measured as sound power (L_{WA}) in conformity with EC directive 2000/14/EC. Reported sound power level for the machine has been measured with the original cutting attachment that gives the highest level. The difference between guaranteed and measured sound power is that the guaranteed sound power also includes dispersion in the measurement result and the variations between different machines of the same model according to Directive 2000/14/EC.

² Reported data for equivalent sound pressure level has a typical statistical dispersion (standard deviation) of 1 dB (A).

³ Reported data for vibration level has a typical statistical dispersion (standard deviation) of 1 m/s².

Approved accessories	Accessory type	Cutting attachment guard, art. no.
Support cup	Fixed	-

EC Declaration of Conformity

EC Declaration of Conformity

Husqvarna AB, SE-561 82 Huskvarna, Sweden, tel: +46-36-146500, declares that the brush cutter **Husqvarna 553RBX** with serial numbers dating from 2016 onwards (the year is clearly stated on the rating plate, followed by the serial number), comply with the requirements of the COUNCIL'S DIRECTIVE:

- of May 17, 2006 "relating to machinery" **2006/42/EC**.
- of February 26, 2014 "relating to electromagnetic compatibility" **2014/30/EU**.
- of May 8, 2000 "relating to the noise emissions in the environment" **2000/14/EC**. Conformity assessment according to Annex V. For information relating to noise emissions, refer to *Technical data on page 25*.
- of June 8, 2011 "on restriction of the use of certain hazardous substances in electrical and electronic equipment" 2011/65/EU.

The following standards have been applied:

EN ISO 12100:2010, CISPR 12:2009, ISO 14982:1998, EN ISO 11806-1:2011, EN ISO 11806-2:2011, EN 50581:2012

RISE SMP Svensk Maskinprovning AB, Box 7035, SE-750 07 Uppsala, Sweden, has carried out voluntary type approval for Husqvarna AB.

The certificate has the number: **SEC/17/2462**

Huskvarna 2016-03-30



Per Gustafsson, Development Manager (Authorized representative for Husqvarna AB and responsible for technical documentation)



www.husqvarna.com

Original instructions

1141422-26



2019-11-01