

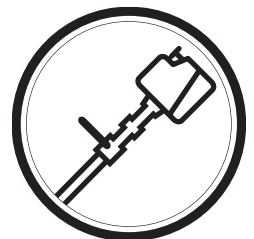

**Operator's manual**  
**532RBS 542RBS**



Please read the operator's manual carefully and make sure you understand the instructions before using the machine.

**English**

---

## SAFETY FIRST

Instructions contained in warnings within this manual marked with a  symbol concern critical points which must be taken into consideration to prevent possible serious bodily injury, and for this reason you are requested to read all such instructions carefully and follow them without fail.

### ■ NOTES ON TYPES OF WARNINGS IN THE MANUAL

#### WARNING

This mark indicates instructions which must be followed in order to prevent accidents which could lead to serious bodily injury or death.

#### IMPORTANT

This mark indicates instructions which must be followed, or it leads to mechanical failure, breakdown, or damage.

#### NOTE

This mark indicates hints or directions useful in the use of the product.

## **Contents**

---

1. Warning labels on the machine .....	3
2. Symbols on the machine .....	4
3. Specifications .....	4
4. Safety precautions .....	5
5. Set up .....	9
6. Fuel .....	12
7. Operation .....	13
8. Maintenance .....	17
9. Trouble shooting .....	21
10. Disposal .....	21

## 1. Warning labels on the machine

---



- (1) Read owner's manual before operating this machine.
- (2) Wear head, eye and ear protection.
- (3) Wear foot protection.
- (4) Wear gloves.
- (5) Beware of thrown objects.
- (6) Warning / Attention
- (7) Keep all children, bystanders and helpers 15 meters away from the machine.

### 📌 IMPORTANT

If warning label peels off or becomes soiled and impossible to read, you should contact the dealer from which you purchased the product to order new labels and affix them in the required location(s).

### ⚠️ WARNING

**Never modify your machine.**

**We won't warrant the machine, if you use the remodeled brushcutter or if you don't observe the proper usage written in the manual.**

## 2. Symbols on the machine

For safe operation and maintenance, symbols are carved in relief on the machine. According to these indications, please be careful not to take a mistake.



(a)

(a) The port to refuel the "MIX GASOLINE"

**Position: FUEL TANK CAP**



(b)

(b) The direction to close the choke

**Position: AIR CLEANER COVER**



(c)

(c) The direction to open the choke

**Position: AIR CLEANER COVER**

## 3. Specifications

Name/Type		HUSQVARNA Backpack Brushcutter		
		532RBS	542RBS	
Handle Type		Loop		
Machine Weight (*1)	kg	8.8	9.0	
Outward Size (L x W x H)		315 x 270 x 410		
Outer pipe	mm	1500 (FL)/1400 (FL-S) ø26		
Applied Head		2-teeth blade(12"), 4-teeth blade, 8-teeth blade, round saw blade(10"), line head		
Power Transmission Method		Automatic centrifugal clutch, spiral gear		
Reduction Rate		1.235 (21 : 17)		
Blade Rotating Direction		Counterclockwise (from operator' s view)		
Type		Single cylinder air cooling 2-cycle gasoline engine		
Engine	Displacement Volume	cc	33.6	41.5
	Fuel Tank Capacity	ℓ	1.3	
	Fuel Used		Lubricating oil mixed gasoline	
	Lubricating Oil Used		2-cycle engine oil	
	Mixing rate		when using HUSQVARNA genuine oil (FC grade): 50:1 when using market oil (FB grade): 25:1	
	Carburetor		float, piston valve	
	Sparking Method		C D I	
	Spark Plug		Champion RCJ-6Y	
	Starting Method		Recoil starter	
	Stopping Method		Sparking Circuit Primary Short (push button)	

(\*1) excluding cutting head, shoulder strap and fuel

Please note that due to improvement, detailed specifications of the product may differ from the information herein.

## ▲ 4. Safety precautions



1. Read this manual carefully until you completely understand and follow all safety and operating instructions.
2. Keep this manual handy so that you may refer to it later whenever any questions arise. Also note, if you have any questions which cannot be answered herein, contact the dealer from whom you purchased the product.
3. Always be sure to include this manual when selling, lending, or otherwise transferring the ownership of this product.
4. Never allow children or anyone unable to fully understand the directions given in the manual to use the machine.



### ■ WORKING CONDITION

1. When using the product, you should wear proper clothing and protective equipment.



- (1) **Helmet**
- (2) **Ear protectors**
- (3) **Protection goggles or face protector**
- (4) **Thick work gloves**
- (5) **Non-slip-sole work boots**

2. And you should carry with you.

- (1) Attached tools
- (2) Properly reserved fuel
- (3) Spare blade
- (4) Things to notify your working area (rope, warning signs)
- (5) Whistle (for collaboration or emergency)
- (6) Hatchet or saw (for removal of obstacles)



3. Do not wear loose clothing, jewelry, short trousers, sandals, or go barefoot. Do not wear anything which might be caught by a moving part of the unit. Secure hair so it is above shoulder length.



### ■ WORKING CIRCUMSTANCE

1. Never start the engine inside a closed room or building. Exhaust gases contain dangerous carbon monoxide.

2. Never use the product,
  - (1) When the ground is slippery or when you can't maintain a steady posture.
  - (2) At night, at times of heavy fog, or at any other times when your field of vision might be limited and it would be difficult to gain a clear view of the working area.
  - (3) During rain storms, during lightning storms, at times of strong or gale-force winds, or at any other times when weather conditions might make it unsafe to use the product.



### ■ WORKING PLAN

1. You should never use the product when under the influence of alcohol, when suffering from exhaustion or lack of sleep, when suffering from drowsiness as a result of having taken cold medicine or at any other time when a possibility exists that your judgment might be impaired or that you might not be able to operate the product properly and in a safe manner.
2. When planning your work schedule, allow plenty of time to rest. Limit the amount of time over which the product is to be used continuously to somewhere around 30 ~ 40 minutes per session, and take 10 ~ 20 minutes of rest between work sessions. Also try to keep the total amount of work performed in a single day under 2 hours or less.



### ▲ WARNING

1. If you don't observe the working time, or working manner (**See "USING THE PRODUCT"**), Repetitive Stress Injury (RSI) could occur.

If you feel discomfort, redness and swelling of your fingers or any other part of your body, see a doctor before getting worse.

2. To avoid noise complaints, in general, operate product between 8 a.m. and 5 p.m. on weekdays and 9 a.m. to 5 p.m. on weekends.



### 📖 NOTE

Check and follow the local regulations as to sound level and hours of operations for the product.

## ▲ 4. Safety precautions

### ■ BEFORE STARTING THE ENGINE

1. The area within a perimeter of 15 m of the person using the product should be considered a hazardous area into which no one should enter. If necessary, yellow warning rope, warning signs should be placed around the perimeter of the area. When work is to be performed simultaneously by two or more persons, care should also be taken to constantly look around or otherwise check for the presence and locations of other people working so as to maintain a distance between each person sufficient to ensure safety.
2. Check the condition of working area to avoid any accident by hitting hidden obstacles such as stumps, stones, cans, or broken glass.



### ❗ IMPORTANT

Remove any obstacle before beginning work.



3. Inspect the entire unit for loose fasteners and fuel leakage. Make sure that the cutting attachment is properly installed and securely fastened.
4. Be sure the cutting attachment guard is firmly attached in place.
5. Always use the harness. Adjust the harness for comfort before starting the engine. The harness should be adjusted so the left hand can comfortably hold the handlebar grip approximately waist high.



### ■ STARTING THE ENGINE

1. Keep bystanders and animals at least 15 m away from the operating point. If you are approached, immediately stop the engine.
2. The product is equipped with a centrifugal clutch mechanism, so the cutting attachment begins to rotate as soon as the engine is started by putting the throttle trigger into the start position. When starting the engine, place the product onto the ground in a flat clear area and hold it firmly in place so as to ensure that neither the cutting part nor the throttle trigger come into contact with any obstacle when the engine starts.

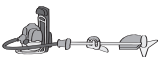
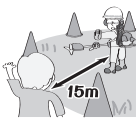

### ▲ WARNING

**Never place the throttle trigger into the high-speed position when starting the engine.**

3. After starting the engine, check to make sure that the cutting attachment stops rotating when the throttle is moved fully back to its original position. If it continues to rotate even after the throttle trigger has been moved fully back, turn off the engine and take the unit to your authorized HUSQVARNA servicing dealer for repair.

### ■ USING THE PRODUCT

#### ❗ IMPORTANT

Cut only materials recommended by the manufacturer. And use only for tasks explained in the manual.



1. Grip the handles firmly with both hands using your whole hand. Place your feet slightly apart (slightly further apart than the width of your shoulders) so that your weight is distributed evenly across both legs, and always be sure to maintain a steady, even posture while working.
2. Keep cutting attachment below waist level.
3. Maintain the speed of the engine at the level required to perform cutting work, and never raise the speed of the engine above the level necessary.
4. If the unit starts to shake or vibrate, turn off the engine and check the whole unit. Do not use it until the trouble has been properly corrected.
5. Keep all parts of your body away from rotating cutting attachment and hot surfaces.
6. Never touch the muffler, spark plug, or other metallic parts of the engine while the engine is in operation or immediately after shutting down the engine. Doing so could result in serious burns or electrical shock.



## ▲ 4. Safety precautions

### ■ IF SOMEONE COMES

1. Guard against hazardous situations at all times. Warn adults to keep pets and children away from the area. Be careful if you are approached. Injury may result from flying debris.
2. If someone calls out or otherwise interrupts you while working, always be sure to turn off the engine before turning around.



### ■ MAINTENANCE

1. In order to maintain your product in proper working order, perform the maintenance and checking operations described in the manual at regular intervals.
2. Always be sure to turn off the engine and disconnect the spark plug wire before performing any maintenance or checking procedures.

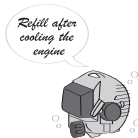

### ▲ WARNING

The metallic parts reach high temperatures immediately after stopping the engine.

3. When replacing the cutting attachment or any other part, or when replacing the oil or any lubricant, always be sure to **use only HUSQVARNA products or products which have been certified by HUSQVARNA for use with the HUSQVARNA product.**
4. In the event that any part must be replaced or any maintenance or repair work not described in this manual must be performed, please contact a representative from the store nearest HUSQVARNA authorized servicing dealer for assistance.
5. Do not use any accessory or attachment other than those bearing the HUSQVARNA mark and recommended for the unit.
6. Under no circumstances should you ever take apart the product or alter it in any way. Doing so might result in the product becoming damaged during operation or the product becoming unable to operate properly.

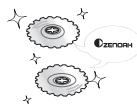

### ■ HANDLING FUEL

1. The engine of the HUSQVARNA product is designed to run on a mixed fuel, which contains highly flammable gasoline. Never store cans of fuel or refill the tank of the unit in any place where there is a boiler, stove, wood fire, electrical sparks, welding sparks, or any other source of heat or fire which might ignite the fuel.
2. Never smoke while operating the unit or refilling its fuel tank.
3. When refilling the tank, always turn off the engine and allow it to cool down. Take a careful look around to make sure that there are no sparks or open flames anywhere nearby before refueling.
4. Wipe spilled fuel completely using a dry rag if any fuel spillage occurs during refueling.
5. After refueling, screw the fuel cap back tightly onto the fuel tank and then carry the unit to a spot 3 m or more away from where it was refueled before turning on the engine.

### ■ TRANSPORTATION

1. When hand-carrying the product, cover over the cutting part if necessary, lift up the product and carry it paying attention to the blade.
2. Never transport the product over rough roads over long distances by vehicle without removing all fuel from the fuel tank. If doing so, fuel might leak from the tank during transport.

### ▲ WARNING

■ **CONTROLLING BLADE THRUST**  
Blade thrust can cause serious personal injury. Carefully study this section. It is important that you understand what causes blade thrust, how you can reduce the chance of blade thrust and how you can remain in control of the unit if blade thrust does occur.

#### 1. What causes blade thrust:

Blade thrust can occur when the moving blade contacts an object that it cannot cut.

## **▲ 4. Safety precautions**

---

This contact causes the blade to stop for an instant and then suddenly move or "bounce" away from the object that was hit. The operator can lose control of the unit and the blade can cause serious personal injury to the operator or any person nearby if the blade contacts any part of the body.

### **2. How you can reduce the chance of blade thrust:**

- (1) Recognize that blade thrust can happen. By understanding and knowing about bounce, you can help eliminate the element of surprise.
- (2) Cut fibrous weeds and grass only. Do not let the blade contact materials it cannot cut such as hard, woody vines and brush or rocks, fences, metal, etc
- (3) Be extra prepared for blade thrust if you must cut where you cannot see the blade making contact such as in areas of dense growth.
- (4) Keep the blade sharp. A dull blade increase the chance of blade thrust.
- (5) Avoid feeding the blade too rapidly. The blade can bounce away from material being cut if the blade is fed faster than its cutting capability.
- (6) Cut only from your right to your left.
- (7) Keep your path of advance clear of material that has been cut and other debris.

### **3. How you can maintain the best control:**

- (1) Keep a good, firm grip on the unit with both hands. A firm grip can help neutralize bounce. Keep your right and left hands completely around the respective handles.
- (2) Keep both feet spread apart in a comfortable stance and yet braced for the possibility that the unit could bounce. Do not overreach. Keep firm footing and balance.



## 5. Set up

### ▲ WARNING

- Assemble each part correctly. Wrong assembly might cause an accident.
- If you cannot do the assembling yourself, consult the shop where you bought this product.

### ■ ATTACHING THE SHOULDER STRAP (SE1)

1. Pass the ring of the shoulder strap through the hook(A) and fix it by the bolt securely.
2. Set the hook(B) of each shoulder strap to the D-rings on the frame.

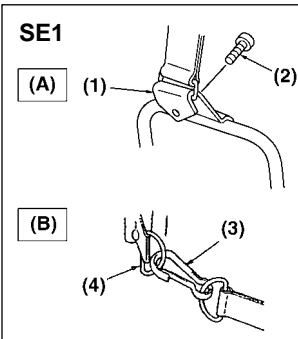

- (A) UPPER SIDE  
(B) LOWER SIDE
- (1) Hook (A)  
(2) Bolt (M5x12)  
(3) Hook (B)  
(4) D-ring

### ■ ATTACHING THE LINER

1. Remove the bolt located on the joint of the outer pipe. (SE2)
2. Match the groove of the liner with the threaded hole and fix with screw securely. (SE2)

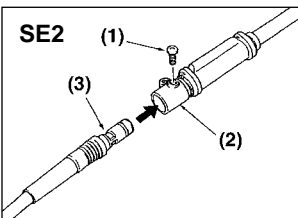

- (1) Bolt  
(2) Joint  
(3) Groove

3. While rotating the flexible shaft located on the opposite end from the liner, insert the flexible shaft into the joint until it is tightly connected. (Note that it is normal at this time for the flexible shaft not to project from the liner.) (SE3)

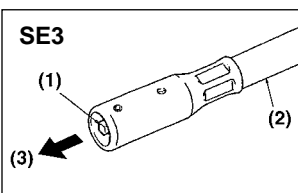

- (1) Flexible shaft  
(2) Liner  
(3) Clutch housing

4. To connect the clutch housing to the liner, lay the liner out straight, align the flexible shaft with the angular hole on the side of the clutch drum, and

insert the liner into the clutch housing, being careful to make sure that the hole on the end of the liner is facing directly upwards. When the hole reaches a point directly below the stopper, you will hear a clicking sound as the stopper moves into the hole to fix the liner into place. (SE4)

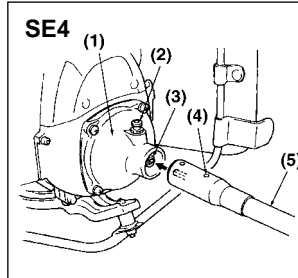

- (1) Clutch housing  
(2) Stopper  
(3) Angular hole  
(4) Hole  
(5) Liner

- If you experience any difficulty in inserting the liner, pull out the liner, rotate the flexible shaft slightly, and try inserting it again.
- Once the liner has been inserted, pull on the liner to make sure that the stopper is properly engaged.

### ⓘ IMPORTANT

After connecting the inner shaft to the shaft of the main pipe, try to pull out the flexible shaft by hand to make sure the flexible shaft does not come off.

### ■ ATTACHING THE THROTTLE CABLE

### ▲ WARNING

After fitting the wire, check if the wire sleeve is correctly fitted to the wire stopper. It is dangerous if the wire sleeve is out of the wire stopper because the engine speed will not decrease even if the throttle lever is released.

- Align the throttle cable along with the liner and tie it with band. (SE5)

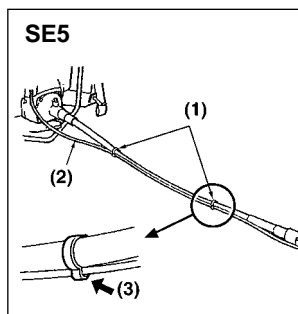

- (1) Band  
(2) Throttle cable  
(3) Tie loosely

1. Hook the cable and into the hole of the throttle lever. And set the cable in the lever as shown in the picture. (SE6)

## 5. Set up

2. Attach the lever as shown in the picture and screw it securely. (SE6)

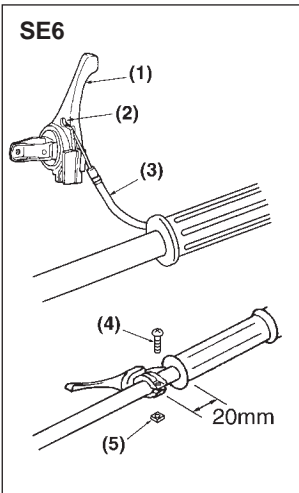

- (1) Throttle lever
- (2) Hole
- (3) Throttle cable
- (4) Screw
- (5) Nut

### ■ ADJUSTING THROTTLE CABLE

- Proper play of the throttle cable is 1–2mm. Place the throttle lever to the lowest speed position (i.e. fully released status). Pull the throttle cable lightly with fingers to check its play. Readjust the position of cable adjuster if the play is too large or too small. To readjust, slacken a lock nut. Turn the cable adjuster clockwise to increase the play, or counterclockwise to decrease the play. Lock the cable adjuster with the lock nut after readjustment. (SE7)

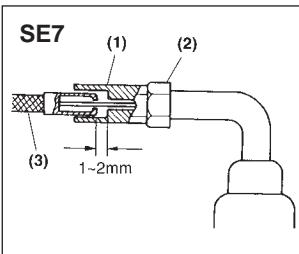

- (1) Cable adjuster
- (2) Lock nut
- (3) Throttle cable

### ■ ATTACHING THE HANDLE

#### NOTE

The loop handle should be located between the arrow mark and the throttle lever.

- Attach the loop handle as shown in the accompanying diagram. Note that it is recommended that you attach the handle so that the handle is located some 30–40cm away from the front end of the right-hand grip. (SE8)

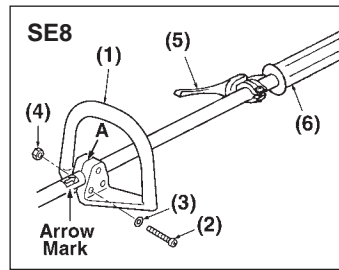

- (1) Loop handle
- (2) Screw
- (3) Washer
- (4) Nut
- (5) Throttle lever
- (6) Right hand grip

#### ▲ WARNING

Stop tightening the screws when the gap A becomes zero.

### ■ ATTACHING THE DEBRIS GUARD

#### ▲ WARNING

Never use the machine without the debris guard.

- Attach the guard to the clamp on the outer pipe just touching the gearcase. Fix it with 2 bolts. (SE9)

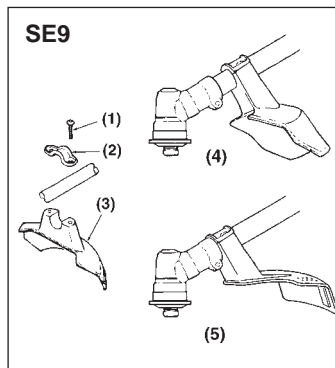

- (1) Bolt (M5x25)
- (2) Clamp
- (3) Debris guard
- (4) Place to be attached for blade use
- (5) Place to be attached for line head

### ■ BLADE

#### ▲ WARNING

- Do not install or remove the blade while the engine is in operation.
- Use HUSQVARNA's genuine replacement blades and metal fixtures when installing the blade.
- When installing or removing the blade, fix the machine securely, and wear robust gloves.
- The blade turns counterclockwise (viewed from the gear case). When using an inside-out blade, check the direction of the blade before installing it. In particular, if you install a chip saw in the wrong direction, the chips might break and scatter.

- Loosen the bolt remove holder A and holder B from the gear case. (SE10)

## 5. Set up

(Note that this is a left-turning screw.)

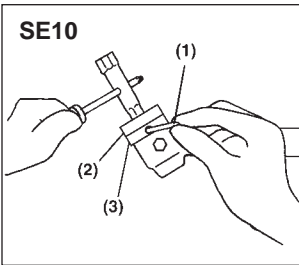

- (1) Bar
- (2) Holder B
- (3) Holder A

2. Attach the cover (SE11,(11)) and fix it with screw.
3. Insert blade between cutter holder A and cutter holder B. (SE11)
4. Attach cover and spring washer. (SE11)
5. Screw the bolt to fix them into place. (SE11)

**Tightening torque:**  
**14.7~19.6 N·m**  
**(150~200kgf·m)**

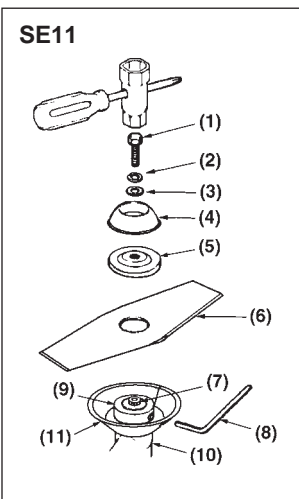

- (1) Bolt
- (2) Spring Washer
- (3) Washer
- (4) Bolt cover
- (5) Holder B
- (6) Blade
- (7) Gear shaft
- (8) Bar
- (9) Holder A
- (10) Gear case
- (11) Cover preventing grass from getting caught up

### ⚠ IMPORTANT

Look at the blade from above, and make sure that the direction in which the blade is mounted is correct. (SE12)

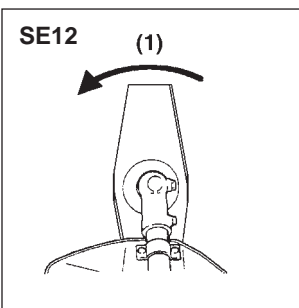

- (1) Rotating direction

### ■ LINE HEAD (SE11) (SE13)

#### ⚠ IMPORTANT

Since the resistance of the nylon cutter is larger than that of the metal cutter, wrong operation of the nylon cutter will cause the clutch to overheat, deform and be damaged. When using the nylon cutter, carefully note the following.

- Use HUSQVARNA's genuine nylon cutter. When using a commercially-available nylon cutter, make sure that it is no longer than 10 cm in external shape.
- Make sure that the length of the nylon cord is 17 cm or shorter.
- Keep the engine rotating at high speed while working.

1. Detach bolt (1), spring washer (2), washer(3), bolt cover (4) and cover (11).
2. Put holder B (5) to holder A (9).  
Screw arbor bolt (12) in holder B (5).
3. Then attach the cutting head to the gear shaft over the holders. Hard-tighten it securely.

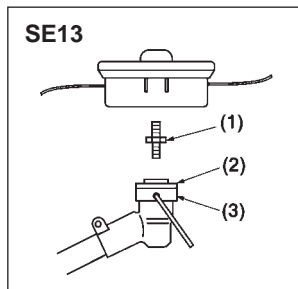

- (1) Arbor bolt
- (2) Holder B
- (3) Holder A

## 6. Fuel

---



### ⚠ WARNING

- Gasoline is very flammable. Avoid smoking or bringing any flame or sparks near fuel.
- Wipe up all spills before starting the engine.
- Make sure to stop the engine and allow it cool before refueling the unit.
- Keep open flames away from the area where fuel is handled or stored.

### ❗ IMPORTANT

- Never use oil for 4 cycle engine use or water cooled 2-cycle engine.
- Never use "FUEL WITH NO OIL (RAW GASOLINE)".
- Never use fuel laced with water.
- Mixed fuels which have been left unused for a period of one month or more may clog the carburetor or result in the engine failing to operate properly. Put remained fuel into an air-tight container and keep it in the dark and cool room.
- Please ask for "mixed gasoline for air-cooled 2-cycle engines" at your nearest gas station, or use fuel made by putting unleaded gasoline for automobiles and air-cooled 2-cycle engine oil into a mixing container in accordance with the following ratios and then shaking to mix well.

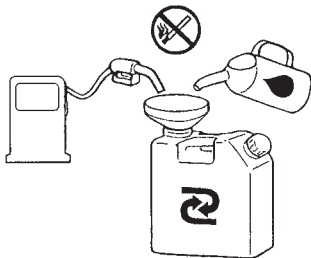

### Mixing ratios:

When using Husqvarna genuine 2-cycle oil (FC grade):

**50:1** (100 ml of oil for  
every 5 liters of gasoline)

When using commercially available 2-cycle oil (FB grade):

**25:1**(160 ml of oil for  
every 4 liters of gasoline)

## 7. Operation

### ■ REFUELING

#### ▲ WARNING

- Refuel the fuel tank in a flat place outdoors. Avoid smoking or bringing any flame or spark near the fuel, and stub out any cigarette.
- When refueling the fuel tank while using this machine, make sure to stop the engine and allow it to cool before refueling the fuel tank.
- Make sure to tighten the fuel-tank cap firmly.
- Wipe up all fuel spills with a dry cloth before starting the engine.

#### 📌 IMPORTANT

Fill the fuel tank to roughly 80% of its capacity. If filled too full, the fuel may leak from the tank cap while using this machine.

1. Place the brushcutter to be refueled in a flat place outdoors, and make sure it is stable.
2. Unscrew the fuel-tank cap a little, and allow the difference of atmospheric pressure between the inside and outside of the fuel tank to equalize.
3. Remove the fuel-tank cap, and fill fuel little by little up to roughly 80%.
4. After filling the fuel, close the fuel-tank cap tightly, and make sure that the fuel does not leak.

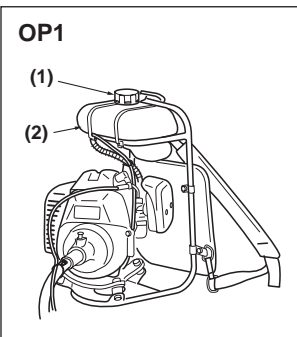

(1) Tank cap  
(2) Fuel tank

### ■ STARTING THE ENGINE

#### ▲ WARNING

- Before starting the engine after filling with fuel, move the machine at least 3 m away from where it was refueled.  
Starting the engine where the machine was refueled might cause a fire.
- Do not start the engine indoors or in any place which is not well ventilated. Otherwise, you might suffer carbon monoxide poisoning which could injure you.

#### ▲ WARNING

- Keep the throttle lever set always to the idling position when starting or stopping the engine, or moving the machine. If the throttle lever is set to any position other than the idling position, the blade will begin to rotate, causing danger.
- The engine might start after a delay. Hold the unit until it starts.

#### ▲ WARNING

- Before starting the engine, check the entire unit for troubles such as looseness in installing the handle, malfunctioning of the throttle lever, looseness in installing the blade, and fuel leaks.
- When starting the engine, place the machine on the ground and hold it securely. Since the blade might touch the ground or object near the machine, do not start the engine while holding up the machine with one hand.
- Do not start the engine with the throttle lever kept pulled because the blade will immediately begin to move upon starting the engine. When starting the engine, place the machine on a flat and firm place, and keep all objects away from the blade.
- When starting the engine, keep all objects away from the machine so that the blade does not touch the ground.
- If the blade continues to rotate even after the throttle lever is returned to the idling position, stop the engine and check the idling adjustment screw of the throttle wire and the carburetor.
- When the engine has started, make sure that the blade does not move. If the blade continues to move, stop the engine, and check the idling adjustment screw of the throttle wire and the carburetor.
- While using the machine, hold the grips of the machine with both hands, and keep your eyes on the blade.
- Do not touch the metal part of the engine body and the muffler while using the machine or immediately after stopping using it, otherwise you might suffer burns.
- Do not touch the spark plug or plug cord while using the machine, otherwise you might suffer an electric shock.

#### 📌 IMPORTANT

If you repeat the starting operation with the choke closed, the electrode of the spark plug may become wet and the engine might not start. If this happens, open the choke, set the throttle lever to the almost fully-open

## 7. Operation

position and pull out the starter rope repeatedly, or try the starting operation again after removing the spark plug and drying the electrode.

1. Open the fuel cock. (OP2)
2. Move the choke lever to the closed position. (OP2)

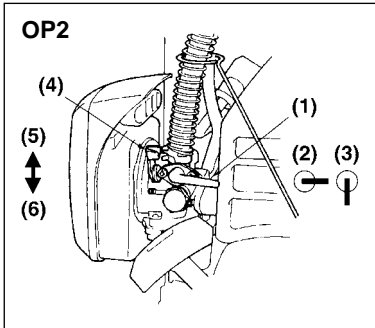

- (1) Fuel cock
- (2) Close
- (3) Open
- (4) Choke lever
- (5) Close
- (6) Open

### NOTE

When restarting immediately after stopping the engine, move the choke lever to the open position.

3. Set the throttle lever to the idling position. (OP3)

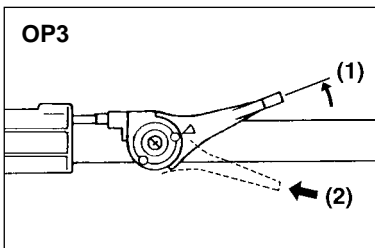

- (1) Idling
- (2) Full throttle

### NOTE

When restarting immediately after stopping the engine, move the throttle lever to the idling position.

4. Place the machine on a flat and firm place, and make sure to keep the blade clear of everything around it. Then, holding the main pipe with your left hand, put your right foot on the frame, and pull out the starter knob with your right hand quickly. (OP4)

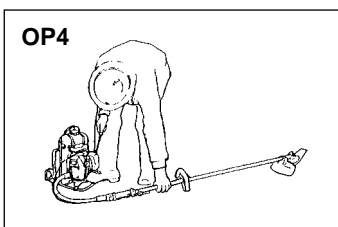

### IMPORTANT

Do not pull out the starter rope up to its end, and do not let the knob jump out of the right hand otherwise it may not return to its original position.

5. After the engine has started, open the choke gradually.
6. Allow the engine to run for 2 to 3 minutes to warm up.

### STOPPING THE ENGINE

#### WARNING

- Stop the engine immediately in an emergency.
- The blade rotates by inertia for a while after the engine has stopped. Do not touch the blade until the engine has stopped completely.
- Do not touch the muffler or spark plug with bare hands immediately after the engine has stopped. Otherwise you may suffer burns because the muffler and spark plug are extremely hot.

1. Return the throttle lever to the idling position.
2. Push the engine switch button. (OP5)
3. Close the fuel cock.

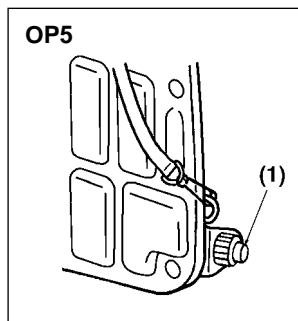

- (1) Engine switch button

### IMPORTANT

If you stop the engine while keeping the revolution speed high, the engine could become damaged. Return the throttle lever to its original position and reduce the engine speed before stopping the engine except in an emergency.

### EQUIPPING THE SHOULDER STRAP (OP6)

1. Hold the main pipe with your right hand. Hang the left strap on your left shoulder.
2. Change your hand to hold the main pipe with your left hand. Hang the right strap on your right shoulder.

## 7. Operation

OP6

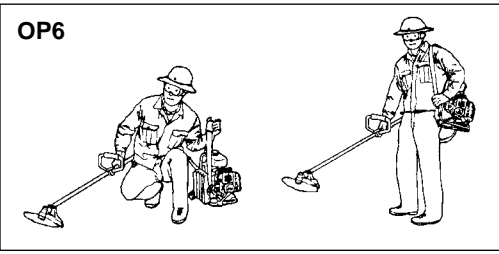

### ■ CUTTING OPERATION

#### ▲ WARNING

- Always wear eye protection such as safety goggles. Never lean over the rotating cutting head. Rocks or other debris could be thrown into eyes and face and cause serious personal injury.
- Keep the debris guard attached in place at all times when the unit is operated.

### BLADE USAGE (OP7)

1. Always cut by guiding the head from your right to left.
2. A metal blade cut best up to the point 1/3 from the edge. Use that area for cutting shrubs, tough and thick weeds. For cutting young grass, you can use up to 2/3 from the tip of blade.
3. Adjust the engine speed according to the cutting objects. Cut the young grass at middle speed, and cut shrubs or tough and thick weeds at high speed.

OP7

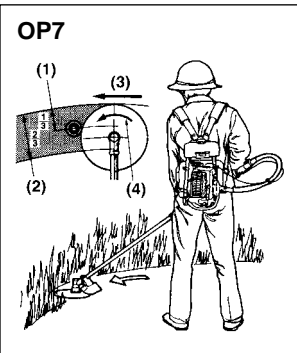

- (1) For branches and trees
- (2) For grass and weeds
- (3) Direction of cutting
- (4) Direction of rotation

#### ❶ IMPORTANT

Operating at low speed makes it easier for grass, weeds, or twigs to become caught up in the blades, and also it makes the shaft and clutch wear down more quickly.

#### ▲ WARNING

When using a metal blade, do not cut grass with the right half of the blade. Otherwise, the machine might blade thrust, causing a serious injury.

OP8

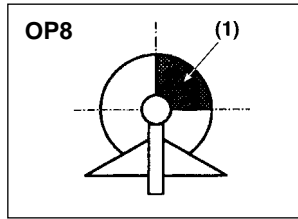

- (1) Area of the blade where the machine is prone to blade thrust

#### ▲ WARNING

- When using this machine, read and obey the precautions and instructions described in “Safety precautions” (pages 5 to 8) of this manual.
- Before shouldering the main body of the brushcutter, return the throttle lever to the idling position and make sure the blade has stopped rotating.
- When shouldering the main body of the brushcutter, be careful that the throttle wire does not get tangled, and that the blade does not touch the ground.

#### ▲ WARNING

This product employs a float type carburetor. If the engine is tilted too much, the fuel in the breather or carburetor of the fuel tank might leak out. Do not tilt the engine upward or downward during cutting, or when storing or transporting the brushcutter.

#### ▲ WARNING

Be careful not to hit the blade against any object during cutting. Hitting the blade against stones, etc. might damage the blade and driving unit, or bend the main pipe.

### LINE HEAD USAGE

- Always remember that the TIP of the line does cutting. You will achieve better results by not crowding the line into the cutting area. Allow the unit to trim at its own pace.
1. Hold the unit so the head is off the ground and is tilted about 20 degrees toward the sweep direction.
  2. Use full throttle when cutting.
  3. You can avoid thrown debris by sweeping from your left to the right.

OP9

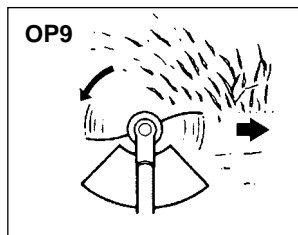

## 7. Operation

---

4. Use a slow, deliberate action to cut heavy growth.  
The rate of cutting motion will depend on the material being cut. Heavy growth will require slower action than will light growth.
5. Never swing the unit so hard as you are in danger of losing your balance or control of the unit.
6. Try to control the cutting motion with the hip rather than placing the full workload on the arm and hands.
7. Take precautions to avoid wire, grass and dead, dry, long-stem weeds from wrapping around the head shaft. Such materials can stall the head and cause the clutch to slip, resulting in damage to the clutch system if repeated frequently.

### **ADJUSTING THE LINE LENGTH**

- Your brushcutter is equipped with a semi- auto type nylon line head that allows the operator to advance the line without stopping the engine. When the line becomes short, lightly tap the head on the ground while running the engine at full throttle.
- Each time the head is bumped, the line advance about 1 inch (25.4 mm). For better effect, tap the head on bear ground or hard soil. Avoid bumping in thick, tall grass as the engine may stall by overload.



## 8. Maintenance

### ■ BLADE

- Sharpen each cutting edge and make sure the bottom corner is rounded. (MA1)
- Do not cool the blade with water in case of using grinder. It may cause cracks on blade.

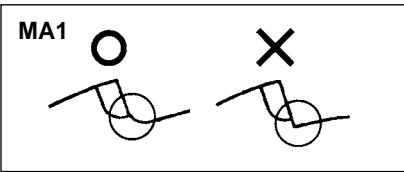

### ■ REFILLING TRIMMING LINE (MA2)

1. For replacement line, use a diameter of .095in (2.4mm). The spool is capable for a line upto 20ft (6m) on the 4" head. Avoid using a larger line as it may cut down the trimming performance.

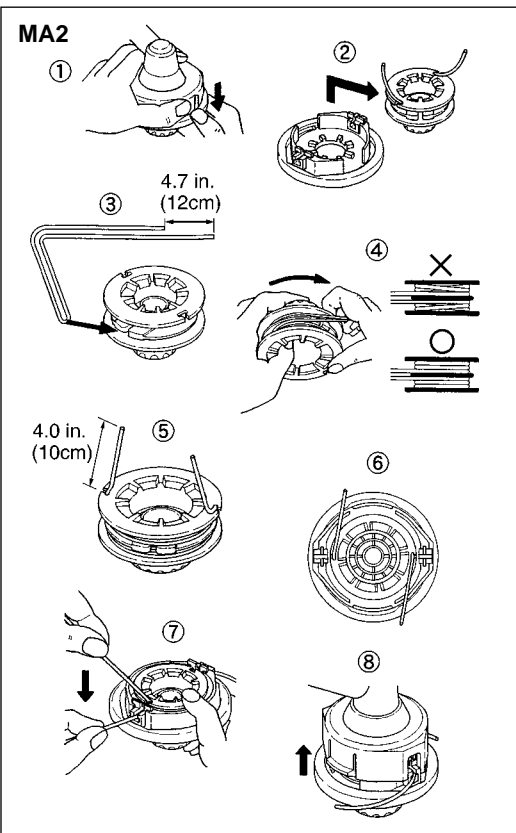

#### ▲ WARNING

For safety reasons, do not use metalreinforced line.

2. Pinch the slotted area on the both sides of the spool housing to unhook the bottom cap.
3. Take out the spool and pull off the old line. Fold new line so that one half line is 4.7in.(12cm) shorter than another half. And then, hook bended end in the slot

of the spool.

4. Wind up the line in the correct direction as indicated on the spool.
5. Hook each end of the line in the slot on the edge of the spool, and then put the ends through the eyelets on the housing. Make sure that the spring and the washers are in place.
6. While holding the spool against the housing, pull the line ends to release them from the slot.
7. Line up the slot on the bottom cap with the hook on the housing, press the cap against the housing until it clicks.

#### ▲ WARNING

**Make sure that the engine has stopped and is cool before performing any service to the machine. Contact with moving cutting head or hot muffler may result in a personal injury.**

### ■ AIR CLEANER

Take off the air-cleaner cover and remove the dust inside the air cleaner every 25 hours of use.

When the air-cleaner element has become extremely contaminated, clean it thoroughly with warm water including a neutral detergent. Install it after drying it completely.

When the air-cleaner element has become deformed or damaged, replace it with a new one.

Part No.: Z1418-82130

#### ● IMPORTANT

If the air-cleaner element becomes clogged, the output of the engine decreases and fuel consumption worsens. If you continue to operate the machine without an air-cleaner element, or with an air-cleaner element which has been deformed or damaged, the inside of the engine will wear severely.

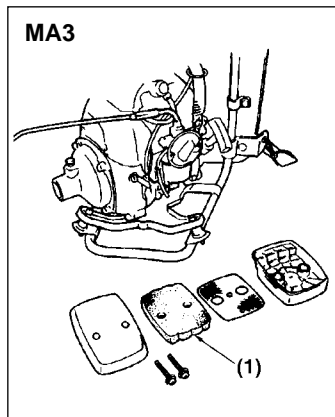

(1) Air-cleaner element

## 8. Maintenance

### ■ FUEL FILTER

#### ▲ WARNING

When you mount or dismount the fuel filter, be careful not to damage the rubber packing. A damaged rubber packing or insufficient mounting of the fuel filter will cause fuel to leak.

Check how heavily the fuel filter is clogged from the fueling port of the fuel tank every 25 hours of use. If the fuel filter is clogged with dust, empty the fuel tank, take the fuel filter out, and clean it with a brush, etc. If the clogging of the fuel filter cannot be removed or the fuel filter is damaged, replace it with a new one.

Part No.: T1154-85100

#### ⓘ IMPORTANT

If the fuel filter is clogged, the engine rotation speed might not increase, or rotation fluctuations might occur.

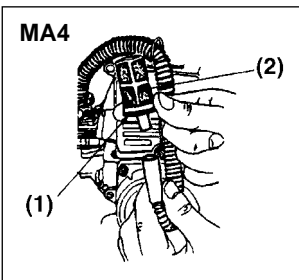

- (1) Rubber packing
- (2) Fuel filter

### ■ SPARK PLUG

#### ▲ WARNING

Do not touch the spark plug with bare hands immediately after stopping the engine. The spark plug is still so hot and might cause burns.

Take out the spark plug, check the electrodes, and if contaminated, clean them with a wire brush, etc. every 25 hours of use.

When mounting the spark plug, screw the plug in with your fingers, and then tighten it with the plug wrench supplied as a standard accessory.

The spark gap should be adjusted to 0.6 to 0.7 mm.

[Tightening torque]  
9.8 to 11.8 N·m  
(100 to 120 kgf·cm)

Designated spark plug  
Champion: RCJ-6Y  
NGK: BPM7A

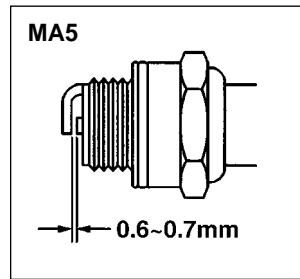

#### ⓘ IMPORTANT

If you use the plug wrench to start tightening the spark plug, the thread might become damaged.

### ■ AIR COOLING VENT

#### ▲ WARNING

Do not put any waste into the intake air-cooling vent while the machine is in operation. It might touch the rotating part, causing danger.

Check the intake air-cooling vent and the cooling fin of the cylinder, and remove any dirt attached thereto every 25 hours of use.

#### ⓘ IMPORTANT

If any waste or dirt is jammed between the intake air-cooling vent and the cylinder fin, the engine might overheat, causing trouble.

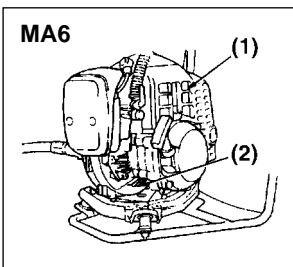

- (1) Cylinder fin
- (2) Intake air-cooling vent

### ■ GEAR CASE

Supply lubricating grease to the gear case every 25 hours of use.

#### Designated grease

Lithium-based heat-resistant grease (#2)

#### [How to supply grease]

1. Remove the blade and the blade rest plate.
2. Remove the plug beside the gear case, and pour tube grease from the plug hole.
3. Stop supplying the grease when all the old grease has been pushed out from the shaft connecting hole

## 8. Maintenance

on the side where the main pipe is installed, and mount the plug in its original position.

- Wipe off the pushed-out grease, and mount the blade and the blade rest plate in their original positions.

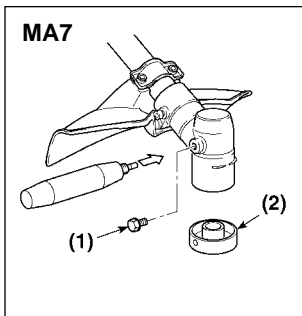

- Plug
- Blade rest plate

### ■ FLEXIBLE SHAFT

Apply grease to the flexible shaft every 25 hours use.

- Take out the flexible shaft while raising the stopper of the clutch housing.
- Take out the inner shaft, apply grease to the surface of the inner shaft, and insert the inner shaft into the liner.

### Designated grease

Lithium-based heat-resistant grease (#2)

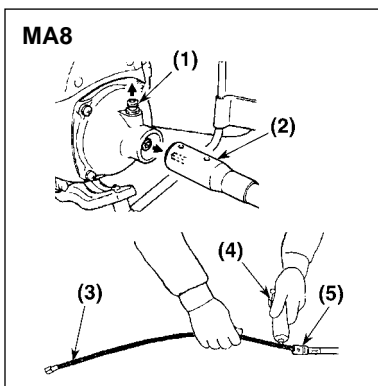

- Stopper
- Liner
- Inner shaft
- Grease
- Liner

### ■ MAINTENANCE EVERY 100 HOURS

- Remove the muffler, insert a screwdriver into the vent, and wipe off any carbon. Also, wipe off any carbon at the muffler outlet.

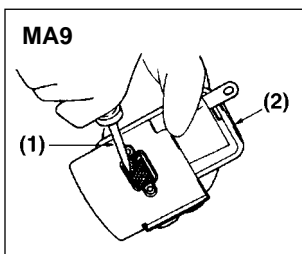

- Screwdriver
- Muffler

- Further tighten all screws, bolts and fittings.
- Make sure that no oil or grease remains between the clutch lining and the drum. If you see any there, wipe it off using oil-free, lead-free gasoline.
- Remove the float chamber of the carburetor, and clean the inside of the float chamber.

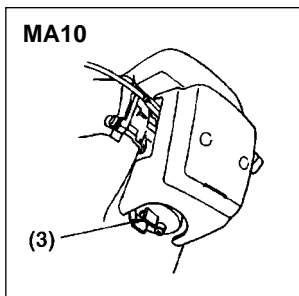

- Float chamber

### ■ ADJUSTING THE ENGINE

#### ▲ WARNING

**Continued rotation of the blade after the throttle lever is set to the idling position could be dangerous. If the blade continues to rotate even after readjusting the idling adjustment screw, the throttle lever, throttle wire, or clutch might be faulty. Contact the shop where you bought this product, and ask it to check and repair the trouble.**

#### ❗ IMPORTANT

- The idling engine speed is adjusted when this product is shipped from the factory, but it might need to be readjusted according to changes in operation conditions (e.g. changes in the stability of the engine, air density, etc.). When readjustment is necessary, try to do so as described below. If this is difficult, contact the shop where you bought this product, and ask it to implement the readjustment.
- Make sure the throttle wire is parallel with the flexible shaft. If the throttle wire is twisted, straighten it.
- If the flexible shaft is bent, the play of the throttle wire changes. When you adjust the idling, bend the flexible shaft and adjust the idling in a standing position similar to the position in which you actually use the machine.

### How to adjust the idling revolution speed

Warm up the engine at a medium speed for a few minutes after starting it. Turn the idling adjustment screw on the carburetor body using the screwdriver supplied as a standard accessory, and adjust the idling revolution speed to an appropriate value (when the throttle lever is returned to its original position, the blade does not rotate, and the engine does not stop).

## 8. Maintenance

The engine revolution speed increases when you turn the idling adjustment screw clockwise, and decreases when you turn it counterclockwise.

**Standard idling revolution speed:  
2,300 to 2,700 rpm**

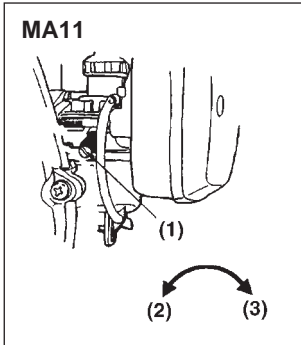

- (1) Idling adjustment screw
- (2) Rotation increases.
- (3) Rotation decreases.

5. Apply a little oil to the blade, put the cover on the blade, and keep the machine in a safe place away from heat and humidity.

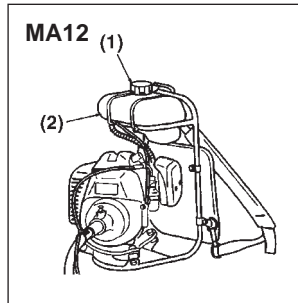

- (1) Tank cap
- (2) Fuel tank

### ■ MAINTENANCE BEFORE LONG-TERM STORAGE

#### ▲ WARNING

This machine is highly inflammable.

- When you take fuel out, keep the fuel tank well away from flames.
- Be careful not to spill the fuel, and completely wipe off all fuel spills.

#### 📌 IMPORTANT

- If you will not use the machine for a long time (two months or more), take out the fuel from the fuel tank and carburetor. If you leave the fuel tank and carburetor filled with fuel for a long time, the fuel might deteriorate and clog the inside of the carburetor, thus causing engine problems (such as wrong start or insufficient output).
- When storing the machine for a long time, loosen the cap of the fuel tank slightly. Excessive tightening of the cap might deform its packing over time.

1. Brush off dirt from the machine, and check the damage or slack of each part. If you find any abnormal part, repair it completely ready for the next time the machine is used.
2. Extract fuel from the fuel tank, switch on the engine, and leave it running until it stops naturally.
3. Remove the spark plug, and pour 1 to 2 ml of 2-cycle oil into the engine. Draw the starter rope two to three times, set the plug back, and stop it at the contraction position.
4. Supply some grease to the gear case, and apply anti-rust oil to the metal parts such as the throttle wire.

## 9. Trouble shooting

PHENOMENON	MAIN CAUSE	MEASURES
The engine does not start.	• Bad fuel (different quality, deterioration)	• Replace it with normal fuel (page 12).
	• Excessive sucking of fuel	• Open the choke, open the throttle full open, and pull out the rope repeatedly (page 13,14).
	• Clogging of the muffler exhaust vent	• Clean the muffler (page 18,19).
	• Contamination of the spark plug electrodes, Short-circuit or breaking of a wire	• Clean the electrodes or replace the plug (page 18☆).
The engine does not accelerate.	• Bad fuel (different quality, deterioration)	• Replace it with normal fuel (page 12).
	• Clogging of the muffler exhaust vent	• Clean the muffler (page 19).
The engine stalls when the throttle is returned to its original position.	• The idling revolution speed is too low.	• Readjust the idling adjustment screw (page 20).
The engine rotation speed changes.	• Clogging of the fuel filter	• Clean or replace the fuel filter (page 18☆).
Abnormal vibration	• Deformation or damage of the blade	• Replace the blade (page 11☆).
Deterioration of fuel consumption	• Clogging of the air cleaner	• Clean the air cleaner (page 17).
	• Blunt blade	• Replace the blade (page 11☆).
	• Bad lubrication of the flexible shaft	• Supply grease (page 19).

- When the symptoms in the left column do not improve after taking the measures in the right column, please contact the shop where you bought this product.
- For the measures marked with ☆, please buy HUSQVARNA's genuine parts at the shop where you bought this product.

### **▲ WARNING**

- **Do not modify or disassemble the machine. Modification or disassembly of the machine might cause the machine to be damaged during operation, or cause an unexpected accident due to the leakage of fuel or malfunction of the machine.**
- **When you carry out inspection or maintenance of the machine, keep the machine clear of fire (such as a lit cigarette). Otherwise, the fuel might catch fire.**
- **Use HUSQVARNA's genuine or dedicated tightening parts (bolts, nuts and screws). Use of other manufacturers' parts might damage the machine, or cause an unexpected accident due to parts falling off while the machine is in operation.**

## 10. Disposal

- When you dispose of the machine, do not disassemble the machine.
- When you dispose of the machine, fuel, oil, be sure to follow your local regulations.







[www.husqvarna.com](http://www.husqvarna.com)

**Original instructions**

**1153989-26**

**2010-11-01**